

## **TERMS OF REFERENCE**

### **FOR**

### **VERIFICATION, CERTIFICATION ISSUANCE AND TRADING/PURCHASE OF VERIFIED CARBON CREDITS OF BIO-CARBON SUB-PROJECT**

#### **Himachal Pradesh Reforestation Project – Improving Livelihoods and Watersheds**

**ASSIGNMENT TITLE:** Selection of a **Firm/Agency/Organization** for verification, certification issuance and trading/purchase of verified carbon credits of bio-carbon sub-project. It includes verifying the CDM project plantation parcels on sampling basis and calculates generated CERs for the project. Further also quote the best CER price for trading/purchase the verified carbon credits.

**BACKGROUND :** The Bio Carbon reforestation project under Clean Development Mechanism (CDM) was registered with UN body (UNFCCC) on March 4, 2011. The project aims to protect watersheds, enhance tree cover, conserve biodiversity, improve livelihoods and generate carbon revenue. The project implemented the work in 139 Gram Panchayats (GPs) creating 292 plantation parcels covering 3216 ha. of degraded land. The focus was on reforestation for which the farmers can receive cash incentive by being potential seller of carbon credits.

#### **(i) Objectives of CDM Project :**

The broad objectives of the Project:

- To sequester Green House Gases (GHG) through reforestation on degraded forest, community and private lands.
- To fulfill global and national environmental objectives to develop innovative cost-effective ways to minimize climate change risks.
- To provide multiple benefits to the poor farmers through meeting their needs of fodder, firewood, timber, minor forest produce.
- Carbon credits (as cash incentive).
- Employment opportunities.

#### **(ii) Project area, carbon stock & carbon revenue**

The A/R project area consists of 292 parcels covering an area of 3216 ha. contained in various land categories viz Forest Land (2943 ha); Community Land (227 ha) and Private land ( 46 ha ) spread over 139 Gram Panchayats (GPs) involving 231 Village Development Societies having 4374 members including 1424 women members.

### **(iii) History of Previous Verification Cycles**

The CDM Project has already gone through two verification cycles for the carbon credits. During the first monitoring cycle (July 2006 to December 2012) and the second monitoring cycle (January 2013 to December 2017) a total of 152 sample parcels were selected for verification and calculation of Carbon Credits. The methodology AR-ACM0001 ver. 3 was used for the verification and calculation of Certified Emission reductions (CERs) during both cycles. The CDM Project is now due for the third monitoring cycle.

### **CLIENT AND INVOICE RECIPIENT**

Chief Project Director  
HP Integrated Development Project  
Solan (173212) HP, India.

### **CONTACTS**

For all issues dealing with contracts, invoices and deliverables will be communicated to CPD, HP-IDP, Solan, Himachal Pradesh (India).

### **REQUESTED SERVICES AND DELIVERABLES**

**Task:** - Verification, Certification and Trading/Purchase of the Verified Carbon Credits.

**Project Design Document (PDD):** India Himachal Pradesh Reforestation Project – Improving Livelihood and Watersheds CDM Ref: 4174 (**Annexure I**)

**Methodology:** AR-ACM0001 ver. 3 – Afforestation and Reforestation of degraded land

**Sample Plots:** 152 (As selected during the first and second verification cycle)

**Host Country:** India

**Project Location:** Himachal Pradesh

#### **Location of the Project Site:**

The Project is located in the mid-altitude region of Himachal Pradesh at elevations ranging between 600 – 1800 meters above mean sea level. The Project area consists of two regions in Himachal Pradesh namely Dharamshala & Bilaspur, encompassing 11 divisions namely Nahan, Swarghat, Solan, Namhol, Kullu, Rampur, Mandi, Sujampur, Dharmshala, Nurpur and Chowari.



**CLEAN DEVELOPMENT MECHANISM  
PROJECT DESIGN DOCUMENT FORM FOR A/R CDM PROJECT ACTIVITIES  
(CDM-AR-PDD)  
(Version 05)**

**TABLE OF CONTENTS**

<b>SECTION A. General description of the proposed A/R CDM project activity</b>	<b>2</b>
<b>SECTION B. Duration of the project activity / crediting period</b>	<b>30</b>
<b>SECTION C. Application of an approved baseline and monitoring methodology</b>	<b>31</b>
<b>SECTION D. Estimation of <i>ex ante</i> actual net GHG removals by sinks, leakage, and estimated amount of net anthropogenic GHG removals by sinks over the chosen crediting period</b>	<b>55</b>
<b>SECTION E. Monitoring plan</b>	<b>69</b>
<b>SECTION F. Environmental impacts of the proposed A/R CDM project activity</b>	<b>81</b>
<b>SECTION G. Socio-economic impacts of the proposed A/R CDM project activity</b>	<b>88</b>
<b>SECTION H. Stakeholders' comments</b>	<b>91</b>
<b>CONTACT INFORMATION ON PARTICIPANTS IN THE PROPOSED A/R CDM PROJECT ACTIVITY</b>	<b>94</b>
<b>INFORMATION REGARDING PUBLIC FUNDING</b>	<b>97</b>
<b>BASELINE INFORMATION</b>	<b>97</b>
<b>MONITORING PLAN</b>	<b>101</b>

**SECTION A. General description of the proposed A/R CDM project activity****A.1. Title of the proposed A/R CDM project activity:**

&gt;&gt;

**India: Himachal Pradesh Reforestation Project – Improving Livelihoods and Watersheds**

Version 07

Date: 02/03/2011 (dd/mm/yyyy)

**A.2. Description of the proposed A/R CDM project activity:**

&gt;&gt;

The project will be implemented in the state of Himachal Pradesh, India. The state is located in the North-Western Himalayan region of India and has 12 districts, which are categorized into four agro-climatic zones, i.e., i) Shiwalik hills, ii) Mid hills, iii) High hills and iv) Cold dry zone. The Mid-Himalayan Watershed Development Project (MHWDP) is implemented in the Siwalik hills at an altitude of 600 to 1800 metres above mean sea level, and covers 11 watershed divisions in 10 districts. The project is spread over an area of 222,951 ha and covers the catchment for major rivers of Northern India - Ravi, Beas and Sutlej.

The project has been developed through a series of consultations with MHWDP and its stakeholder constituents namely, Forest Department, Government of Himachal Pradesh, local Gram Panchayats (GPs) and the World Bank. The project seeks to implement A/R CDM activities on 4,003.07 ha of degraded lands in the watersheds of Mid-Himalayan region.

The four guiding principles of the project are: (i) adoption of native and locally preferred tree species for reforestation, (ii) involvement of the local GPs and small and marginal farmers in reforestation activities that will strengthen the ongoing watershed interventions, (iii) facilitation of technical, financial and capacity development support from MHWDP to reforestation activities, and iv) distribution of carbon revenue to the village community (GP and farmers).

The major objectives of the project are:

- improvement of the productive potential of the degraded land or watershed catchment areas and enhance biomass production and carbon stocks in degraded lands, and
- improvement of livelihoods and incomes of rural households residing in the selected watersheds of MHWDP, using socially inclusive and institutionally and environmentally sustainable approaches.

The project is expected to bring value addition to the ongoing physical catchment/drainage treatment activities undertaken as part of the MHWDP. It seeks to restore degraded lands through reforestation activities. The three plantation forestry models considered for the purpose are outlined below.

- i) *Restoration forestry model:* In this model, reforestation of degraded undemarcated forestland is proposed with a tree density of 1,100 plants/ha. The species to be planted under this model include largely the native species. This model aims to protect the watersheds and regenerate the native flora, supplemented with planting of native tree species on degraded sloping high altitude lands of selected GPs. This is also projected to lead to conservation of biodiversity. Regenerated



**PROJECT DESIGN DOCUMENT FORM  
FOR AFFORESTATION AND REFORESTATION PROJECT ACTIVITIES (CDM-AR-PDD) - Version 05**

- forests are expected to provide non-timber forest products to local communities and improve their livelihood opportunities. This model is proposed to cover 3,176.86 ha.
- ii) *Community forestry model:* This model is proposed for reforestation of degraded community lands (common land). The species included in this model are largely native species. The reforestation activity will lead to protection of watersheds, improvement in biomass required to meet the local community needs of small timber, fuelwood (woody litter), fodder for livestock and non-timber forest products. This model is expected to cover about 293.06 ha and the density of planting in this model is 1,100 trees per hectare.
- iii) *Farm forestry model:* This model covering an area of 533.15 ha includes reforestation of abandoned or long-term fallow private lands with tree species aimed at largely providing fruits and fodder to the land owners. The density of planting is 1,100 trees per hectare. Land owners will also derive fuelwood from fallen woody litter. This will provide employment to the land owners apart from protecting the abandoned land.

The project will be implemented by the MHWDP. Many of the project activities such as protection and management would involve participation of local panchayats and their delegated committees.

The A/R CDM project is developed under the umbrella of the World Bank funded MHWDP Project and it is expected to sequester 828,016 tCO<sub>2</sub>-e of tCERs over the first crediting period of 20-years at the rate of 10.34 tCO<sub>2</sub>-e/ha/year.

The A/R CDM project contributes to sustainable development in the following ways:

- The project seeks to restore highly vulnerable degraded lands - forestland (undemarcated forests), degraded community land and degraded and abandoned private lands in the Mid-Himalayan watersheds, which are subjected to severe soil erosion and unsustainable land use practices.
- The project proposes to involve local communities, particularly small and marginal farmers in plantation activities on degraded common lands, degraded forestlands and private degraded lands through planting of multi-purpose species and implementing sustainable forest management practices.
- The project will generate employment through silvicultural activities such as nursery raising, site preparation, seedling transportation, planting, fencing and maintenance of plantations. About 343 person days/ha of employment is expected to be generated from the implementation of three models during the project period (see Table A.2.1).
- The project activities will promote biodiversity conservation, soil conservation and environmental protection through planting and protection of native tree species, reduction in soil erosion and prevention of downstream siltation of water bodies.
- The three proposed models of reforestation will provide multiple products to the local communities and livelihood activities.



## CDM – Executive Board

**PROJECT DESIGN DOCUMENT FORM  
FOR AFFORESTATION AND REFORESTATION PROJECT ACTIVITIES (CDM-AR-PDD) - Version 05**

- The carbon revenues accrued from the project will be transferred to gram panchayats and individual participating farmers through a pre-project agreement between project implementing agency and gram panchayats.

The MHWD project includes several activities that promote livestock development, fodder production, infrastructure development, institutional capacity enhancement, improvement of livelihoods and poverty alleviation.

The project will be implemented and managed by the MHWD project authorities till 2013 and beyond (if extended), and subsequently the state forest department will manage the project. The Project Directorate will manage and transfer the carbon revenue to local stakeholders - panchayats and individual farmers. In addition to carbon revenue, the restoration, community and farm forestry activities will provide direct benefits to the local communities through land reclamation, increase biomass supply and livelihood opportunities and promote regional and national development.

**Table A.2.1:** Employment generation potential of different reforestation models during implementation of the reforestation project activities (in person days/ha)

Activities	Restoration model	Community forestry model	Farm forestry model
Nursery raising	55	55	40
Transportation	36	36	20
Land preparation	14	14	14
Planting	65	65	45
Fencing	40	40	40
Maintenance & others	150	150	111
<b>Total person days/ha</b>	<b>360</b>	<b>360</b>	<b>270</b>

**A.3. Project participants:**

>>

The project participants and parties involved and their contact information is provided in Annex 1 and the table below.

Name of Party involved (*) ((host) indicates a host Party)	Private and/or public entity(ies) project participants (*) (as applicable)	Indicate if the Party involved wishes to be considered as a project participant (Yes/No)
Government of India (host)	HP Mid-Himalayan Watershed Development Project (MHWDP)	No
Kingdom of Spain	International Bank for Reconstruction and Development (IBRD) as a trustee for BioCarbon Fund (BioCF)	Yes

**A.4. Description of location and boundaries of the A/R CDM project activity:**

**A.4.1. Location of the proposed A/R CDM project activity:**

>>

The proposed project will be implemented in the mid-altitude region of Himachal Pradesh at elevations ranging between 600 and 1800 metres above mean sea level. The project area consists of two regions namely Dharamshala and Bilaspur, encompassing 11 divisions namely Nahan, Swarghat, Solan, Namhol, Kullu, Rampur, Mandi, Sujampur, Dharamshala, Nurpur and Chowari. The project location is depicted in Figure A.4.1. Figure A.4.1 shows all the districts of Himachal with project divisions demarcated.

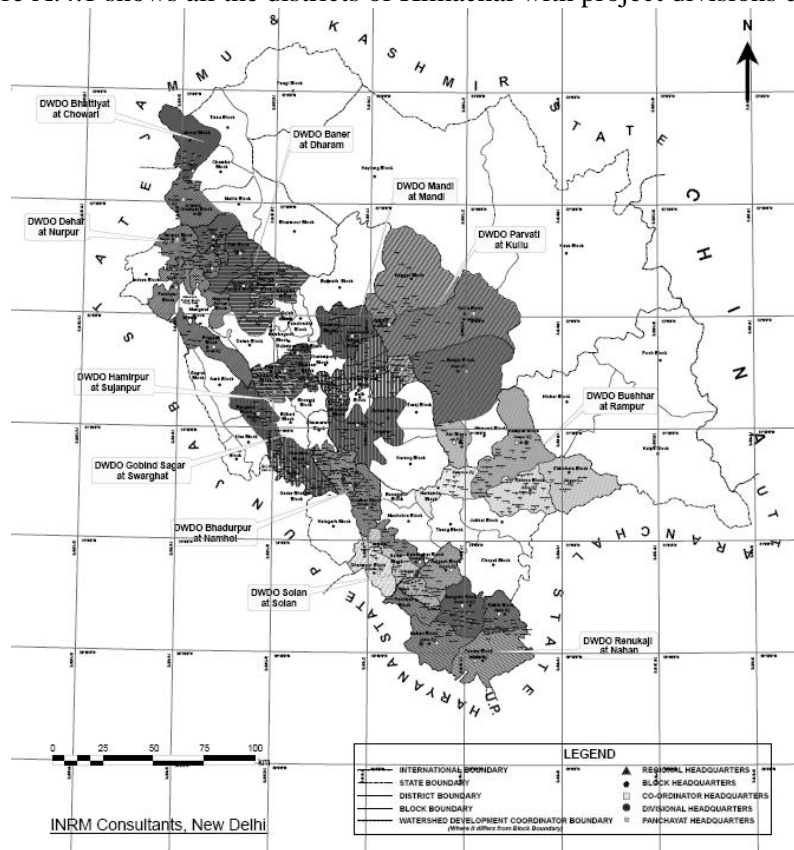

**Figure A.4.1:** Map of Himachal Pradesh with watershed divisions marked and selected divisions identified

**A.4.1.1. Host Party(ies):**

>>

India

**A.4.1.2. Region/State/Province:**

>>

Bilaspur and Dharamshala regions encompassing 11 watershed divisions, of Himachal Pradesh constitute the project area.



**PROJECT DESIGN DOCUMENT FORM  
FOR AFFORESTATION AND REFORESTATION PROJECT ACTIVITIES (CDM-AR-PDD) - Version 05**

**A.4.1.3. City/Town/Community (if applicable):**

>>

Villages in the two administrative regions of the watershed project namely Bilaspur and Dharamshala constitute the project area.

**A.4.2 Detailed geographic delineation of the project boundary, including information allowing the unique identification(s) of the proposed A/R CDM project activity:**

>>

***Project boundary***

Gram panchayat is the empowered administrative as well as decision making unit on project activities, where local communities are organized into a local government, under the Panchayat Act. The A/R project area consists of GPs distributed over 11 watershed divisions of Himachal Pradesh. Each GP has a geographic boundary consisting of a few villages or wards.

The project utilizes remote sensing maps and Participatory Rural Appraisal techniques in selection of gram panchayats and land categories suitable for A/R activities. The project area consists of a cluster of multiple discrete parcels of land, ranging from 0.2 to 149 ha in each GP. The multiple discrete parcels of land include degraded forestland or degraded common land or degraded and abandoned private land.

- The first level of selection was based on the remote sensing maps which provided the tree crown density information, where GPs with significant land area with crown density <10% were identified.
- After identifying the GPs using the remote sensing data, Participatory Rural Appraisal (PRA) was conducted by the project authorities involving gram panchayat members as well as the local community, to identify the actual land availability for A/R CDM project activity, considering the land requirements of community for grazing, and other biomass needs.
- Based on remote sensing maps and further supported by PRA, the GPs where land is available and where village communities are ready were identified and plotted on a map of the project area.

In each of the selected GPs, the final selection of plots for project activities was made using the following steps:

- Cadastral maps with various land uses and land survey number procured
- PRA to identify different land categories and their location conducted
- Data from Forest Department and revenue authorities on the extent of different land categories obtained
- Area of each parcel estimated, based on revenue records as well as GPS readings
- GPS survey of all the parcels of land was done to generate boundaries and measure area of the land parcel
  - o Details of land cover and features around the identified parcel of land are recorded using a form
- Point locations of the land parcels were downloaded to give a point vector coverage
- Point coverage showing central points of the parcels was then overlaid on the remote sensing data
- Details recorded on the field forms were then used to delineate the identified parcels of the land on the remote sensing data by on-screen digitization of the polygons





**PROJECT DESIGN DOCUMENT FORM  
FOR AFFORESTATION AND REFORESTATION PROJECT ACTIVITIES (CDM-AR-PDD) - Version 05**

- Once the land parcels were delineated on the satellite image, suitable maps of the same on a scale of 1:10,000 showing high resolution satellite image in the background, were generated to facilitate demarcation of the land on the ground
- The boundaries of discrete areas will be stored in a GIS database.

The details of each parcel of land – the land category, unique geographical identification code, the farmer’s name and survey number in case of private lands are recorded. Results of monitoring of location, latitude and longitude of each discrete parcel of land belonging to degraded forest, community land and private land for a sample GP is presented in Table A.4.1. The total number of parcels of land in 177 GPs is 420. The results for the remaining GPs are provided in Annex 3. The geographical location of all project GPs is provided in the GIS file provided in Attachment Response to CAR\_1.

A summary of the total land area belonging to the three land categories is as follows:

- Degraded forestland – 3176.86 ha
- Degraded community land – 293.06 ha
- Degraded private land – 533.15 ha

**Table A.4.2:** Illustration of geographical location of land parcels for the project in Palog panchayat belonging to Namhol watershed division (geographical location for the remaining panchayats will be provided at the time of validation)

Code	Land category	Latitude	Longitude	Altitude (m)	Area (ha)
NM046F1	Degraded forestland	31° 08'48.8"	077°00'43.7"	1162	8.8
		31° 08'53.1"	077°00'44.1"	1191	
		31°08'54.5"	077°00'41.8"	1216	
		31°09'00.1"	077°00'41.7"	1242	
		31°09'02.4"	077°00'50.6"	1269	
		31°08'59.3"	077°00'53.0"	1266	
		31°08'49.8"	077°00'48.6"	1223	
		31°08'46.3"	077°00'50.7"	1194	
		31°08'48.9"	077°00'43.6"	1172	
		31°08'14.1"	077°00'53.1"	1213	
NMO46F2	Degraded forestland	31°08'12.7"	077°00'48.9"	1246	11.0
		31°08'10.5"	077°00'42.1"	1281	
		31°08'09.5"	077°00'36.1"	1257	
		31°08'15.5"	077°00'34.8"	1239	
		31°08'19.5"	077°00'34.6"	1210	
		31°08'18.1"	077°00'39.2"	1185	
		31°08'22.5"	077°00'45.3"	1184	
		31°08'19.5"	077°00'52.1"	1196	
		31°08'13.9"	077°00'53.4"	1215	

The methodology AR-ACM0001 Version 03 is applied to the project. Each discrete parcel of land in the project is identified by a unique geographic code and boundary. The discrete parcels of land are defined by polygons, and to make the boundary geographically verifiable and transparent, the GPS coordinate for corners of large polygons are recorded, archived and listed.

**A.5. Technical description of the A/R CDM project activity:****A.5.1. Concise description of the present environmental conditions of the area planned for the proposed A/R CDM project activity, including:**

Himachal Pradesh is almost wholly mountainous with a deeply dissected topography, complex geological structure and rich temperate flora in the sub-tropical latitudes. Physiographically, the state can be divided into five zones – viz. (i) Wet Sub-temperate zone, (ii) Humid Sub-temperate zone, (iii) Dry temperate-alpine High land, (iv) Humid Sub-tropical zone, and (v) Sub-Humid Sub-tropical zone. Wet Sub-temperate zone comprises Palampur and Dharamshala of Kangra District, Jogindernagar area of Mandi district and Dalhousie area of Chamba district, Humid Sub-temperate zone comprises the districts of Kullu, Shimla, parts of Mandi, Solan, Chamba, Kangra and Sirmour, Dry temperate-Alpine High land include major parts of Lahaul-Spiti, Pangi and Minnaur, Humid Sub-tropical zone consists district Sirmour, Bhattiyat valley of district Chamba, Nalagarh area of district Solan, Dehragopipur and Nurpur areas of district Kangra, Sub-humid tropical zone Sirmour and Indora area of district Kangra.

**A.5.1.1. Climate:**

Climatically, Himachal Pradesh can be divided into three zones (i) The outer Himalayas, (ii) The Inner Himalayas and (iii) Alpine zone. The first zone gets an annual rainfall between 150 cms to 175 cm. In the second zone, it varies between 75 to 100 cm and the Alpine zone remains under snow for about five to six months. The average annual rainfall in the state is about 160 cm. The climate varies between hot and humid in the valley areas to freezing cold in the home of perpetual snow.

**A.5.1.2. Hydrology:**

Five perennial rivers Sutlej, Beas, Ravi, Chenab and Yamuna flow through its territory. The utility of these rivers though restricted considerably by the rugged and undulating terrain of the state, nevertheless, these rivers possess immense potential for generation of hydro-electricity. The state of Himachal Pradesh forms the catchment for these large rivers and the health of the hills and catchment is critical for the rivers.

**A.5.1.3. Soils:**

The soils of Himachal Pradesh can be divided into nine groups on the basis of their development and physio-chemical properties. These groups are alluvial soils, Brown hill soils, Brown earths, Brown forest soils, Grey wooded or Podzolic soils, Grey brown podzolic soils, Plansolic soils, Humus and iron Podzols and Alpine humus mountain skeletal soils.

**A.5.1.4. Ecosystems:****Flora and Fauna**

- Wide altitudinal ranges and varied topography of Himachal Pradesh has resulted in making the state a very rich repository of wild fauna and flora. The rugged terrain and clearly distinct agro-climatic/ physiographic zones in the State harbour area specific animals and plants.
- It has been estimated that 66% of the land area is covered with forests. The southern tracts are dominated by sal, sisham, chir pine, dry deciduous and moist broad-leafed forests. The temperate region consists of oaks, deodar, blue pine, fir and spruce. In the uppermost region, trees are



**PROJECT DESIGN DOCUMENT FORM  
FOR AFFORESTATION AND REFORESTATION PROJECT ACTIVITIES (CDM-AR-PDD) - Version 05**

sturdy with a vast network of roots, such as Alders, birches, rhododendrons and moist alpine scrubs. The rhododendrons can be seen along the hillsides around Shimla from March to May.

- Whereas, Snow Leopard, Ibex and Snow Cock have made cold deserts their home, the cold temperate regions of the state form natural habitat of Musk Deer, Himalayan Tahr, Brown Bear, Monal and Western Tragopan<sup>1</sup>. The lower reaches of the state abound with Sambhar Deer, Barking Deer, Wild Boar, Ghoral and Leopard amongst mammals and pheasants including Cheer and White Crested Kaleej. The state has an inventory of more than 3,500 higher plants, many of which are endemic to the region and many form the basis of local health traditions.
- To conserve the entire range of biodiversity in situ, the state has established a network of Protected areas, comprising 2 National Parks and 32 Wildlife Sanctuaries. Pin Valley National Park forms the natural habitat of a number of endangered animals including Himalayan Ibex, Snow Leopard, Bharal, Wooly Hare, Tibetan Wolf, and Snow Cock<sup>2</sup>.

#### ***Endangered fauna***

Among the faunal species that are under threat are Himalayan Ibex, Snow Leopard, Bharal, Wooly Hare, Tibetan Wolf, and Snow Cock.

#### ***Wildlife sanctuaries and national parks***

Himachal Pradesh has 32 sanctuaries, 2 national parks and 3 game reserves. The total area covered under protected area is 12% of forest area in the state. Shikari Devi Wild Life Sanctuary is very near to the project site. The general occurrence of the wildlife in the high forests includes large animals such as Tiger and Panther. Pin Valley is located in the cold desert region of the Spiti valley. Great Himalayan National Park in Himachal Pradesh was established in 1984 and is spread over an area about 754 km.

#### ***Endangered flora<sup>3</sup>***

Result of a special exercise (Shimla CAMP Workshop, 1998<sup>4</sup>) to assess the conservation status of priority medicinal plants, a subset of the listed NTFPs of the state, reveals that 60 medicinal plant species of Himachal Pradesh are facing various categories of threat as per IUCN guidelines. Whereas 12 of these species have been classified as ‘Critically Endangered’, 21 species are ‘Endangered’ and 27 species have been assessed as ‘Vulnerable’. Category-wise list of these Red Listed medicinal plants is given below:

<b>Critically endangered species</b>	<b>Endangered species</b>	<b>Threatened species</b>
<i>Aconitum heterophyllum</i>	<i>Aconitum deinorrhizum</i>	<i>Aconitum violaceum</i>
<i>Arnebia benthami</i>	<i>Angelica glauca</i>	<i>Allium stracheyi</i>
<i>Arnebia euchroma</i>	<i>Betula utilis</i>	<i>Bergenia stracheyi</i>
<i>Atropa acuminata</i>	<i>Datisca cannabina</i>	<i>Bunium persicum</i>
<i>Dactylorhiza hatagirea</i>	<i>Dioscorea deltoidea</i>	<i>Cinnamomum tamala</i>
<i>Dienia mucifera</i>	<i>Ephedra gerardiana</i>	<i>Colchicum luteum</i>
<i>Gentiana kurroo</i>	<i>Fritillaria roylei</i>	<i>Didymocarpus pedicillata</i>

<sup>1</sup> Arun Kumar\* & Vinod Khanna\*\*. Globally Threatened Indian Fauna: Status, Issues and Prospects, Zoological Survey of India, Northern Regional Station, Dehra Dun – 248 195

<sup>2</sup> <http://hpforest.gov.in/wild2.htm>

<sup>3</sup> NTFP as Livelihood Option; Report of Foundation for Revitalisation of Local Health Traditions, Bangalore (Work done for HPMHWDP (2008) and -Ved, DK, et al 2003; Conservation Assessment & Management Prioritisation for the Medicinal Plants of J & K, Himachal Pradesh & Uttaranchal: Shimla CAMP Report, FRLHT. Bangalore.

<sup>4</sup> Conservation Assessment and Management Plan Workshops Report, 1998



**PROJECT DESIGN DOCUMENT FORM  
FOR AFFORESTATION AND REFORESTATION PROJECT ACTIVITIES (CDM-AR-PDD) - Version 05**

<i>Lilium polyphyllum</i>	<i>Habenaria intermedia</i>	<i>Embelia tsjeriam-cottam</i>
<i>Rauwolfia serpentine</i>	<i>Hyoscyamus niger</i>	<i>Eremostachys superb</i>
<i>Saussurea gossypiphora</i>	<i>Juniperus polycarpus</i>	<i>Ferula jaeskeana</i>
<i>Saussurea obvallata</i>	<i>Jurinea dolomiaea</i>	<i>Gloriosa superb</i>
<i>Swertia chirayita</i>	<i>Meconopsis aculeate</i>	<i>Heracleum lanatum</i>
	<i>Nardostachys grandiflora</i>	<i>Hippophae rhamnoides</i>
	<i>Paris polyphylla</i>	<i>Hypericum perforatum</i>
	<i>Picrorhiza kurroa</i>	<i>Hyssopus officinalis</i>
	<i>Podophyllum hexandrum</i>	<i>Litsea glutinosa</i>
	<i>Polygonatum cirrhifolium</i>	<i>Physochlaena praealta</i>
	<i>Rheum emodi</i>	<i>Polygonatum multiflorum</i>
	<i>Rheum moorcroftianum</i>	<i>Polygonatum verticillatum</i>
	<i>Taxus wallichiana</i>	<i>Rheum speciforme</i>
	<i>Zanthoxylum armatum</i>	<i>Rheum webbianum</i>
		<i>Rhodiola heterodonta</i>
		<i>Rhododendron anthopogon</i>
		<i>Rhododendron campanulatum</i>
		<i>Rhododendron lepidotum</i>
		<i>Roylea cinerea</i>
	<i>Valeriana jatamansi</i>	

**Land use change**

The net sown area of Himachal Pradesh has declined over the past decades. This indicates that there is no shift of non-cropland such as forest, revenue and common land to agricultural land. The Forest Conservation Act, 1980 of the Government of India has banned conversion of forestland to non-forest uses. Thus, the degraded forest and community land cannot be converted to agriculture or horticulture. Thus, the most plausible baseline scenario is continued degradation of forest and community land, in the absence of the proposed A/R CDM project. Even the private degraded and abandoned land parcels have remained in that state for more than 10 years (as shown by household survey). Thus the most plausible scenario in the absence of interventions is further degradation of such lands.

**State of forests**

According to the latest remote sensing assessment by the Forest Survey of India, the total area under forests in Himachal Pradesh is 14,369 sq. km (Table A.5.1). This accounts for about 26% of the geographic area as against the National Forest Policy 1988 requirement of 2/3<sup>rd</sup> of the area to be under forest/tree cover for hilly states. Of the total area under forests, 37.9% is under open forest with 10-40% tree crown cover. When the changes in the area under different tree crown classes is considered, it can be observed from Table A.5.2 and Figure A.5.1 that the area under dense forest has declined while the area under open forest has increased (by 82%) over the period 1997 to 2005. This indicates that the forests in Himachal Pradesh are in continuous degradation as a result of biomass loss.

**Table A.5.1:** District-wise area under forest in Himachal Pradesh for 2005 (sq. km.)

District	Geographic area	Very dense (VD)	Moderately dense (MD)	Open forest (O)	Total
Bilaspur	1167	11	93	258	362
Chamba	6528	436	1131	843	2413



## CDM – Executive Board

**PROJECT DESIGN DOCUMENT FORM  
FOR AFFORESTATION AND REFORESTATION PROJECT ACTIVITIES (CDM-AR-PDD) - Version 05**

Hamirpur	1118	3	106	133	242
Kangra	5739	134	1250	495	1879
Kinnaur	6401	16	324	258	597
Kullu	5503	117	1297	527	1941
Lahaul Spiti	13835	7	28	150	185
Mandi	3950	78	929	644	1651
Shimla	5131	192	1576	611	2379
Sirmaur	2825	59	628	692	1379
Solan	1936	39	311	473	823
Una	1540	5	158	355	518
<b>Total</b>	<b>55673</b>	<b>1097</b>	<b>7831</b>	<b>5441</b>	<b>14369</b>

*Very dense - >70% crown cover, moderately dense – 40-70% crown cover; O – 10-40% crown cover*

According to the Forest Survey of India, area under dense forest has declined and area under open forests has increased during the last decade (Table A.5.2).

**Table A.5.2:** Area (sq. km) under forests in Himachal Pradesh during 1997-2005

Tree crown density	1997	1999	2003	2005
Dense forest (crown density >40%)	9,560	9,120	8,976	8,928
Open forest (crown density (10 to 40%))	2,961	3,962	5,377	5,441
<b>Total</b>	<b>12,521</b>	<b>13,082</b>	<b>14,353</b>	<b>14,369</b>

Source: FSI Reports

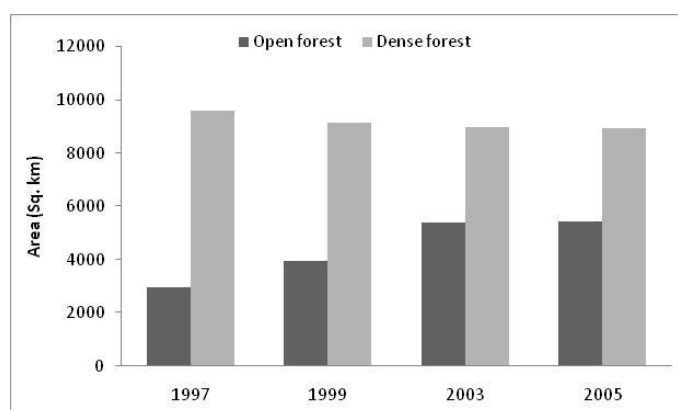

**Figure A.5.1:** Change in area under dense and open forest during the period 1997 to 2005 (FSI reports)

Forests in the state are subjected to degradation, due to anthropogenic pressure. Degraded or open forests are subjected to unsustainable harvesting of timber and non-timber products and heavy infestation of weeds. This has led to thinning of forest cover, loss of biodiversity, reduced biomass productivity, changes in plant community structure and composition, disturbed nutrient cycle and reduced organic carbon in soil. As a consequence, these forests have limited capacity to regenerate by natural means under the prevailing land use.

#### Rate of A/R activity to restore degraded lands



**PROJECT DESIGN DOCUMENT FORM  
FOR AFFORESTATION AND REFORESTATION PROJECT ACTIVITIES (CDM-AR-PDD) - Version 05**

The area under wasteland in Himachal Pradesh is estimated to be 2.84 Mha (Million ha)<sup>5</sup> (NRSA 2003). At the current rate of A/R, of the latest year 2004 of 13,414 ha annually, over 200 years are required to afforest or reforest all the potential wastelands. If the survival rate of plantations is considered, the time period required for A/R would be even longer. Thus, large parts of wastelands or degraded lands are unlikely to be afforested under the normal A/R programmes in the coming decades and would remain in degraded state in the foreseeable future.

**A.5.2. Description of the presence, if any, of rare and endangered species and their habitats:**

There are no threatened and endangered species in the project area. Assessment of the project area for endangered species was done in the following manner:

Vegetation survey was conducted as part of the baseline study. The vegetation survey included recording of all plant species present in the sample plots. Based on this survey, it can be concluded that there are no endangered flora in the project area as none were encountered during this baseline survey. The team also did not come across any of the endangered fauna during these surveys. Further, the Focus/Concentration of endangered species is in the Protected Area Network (Wild Life Sanctuaries & National Parks). None of the project parcels fall within the Protected Area Network of Himachal Pradesh.

**A.5.3. Species and varieties selected for the proposed A/R CDM project activity:**

***Criteria for selection of species***

The selection of species is based on the suitability for the altitude, slope or topography and site quality. Focus was on native species or species that are highly adapted to the location. Further, among the suitable species, those with high to moderate growth rate of biomass and ability to provide multiple benefits to the community were selected.

The criteria used for selecting tree species included;

- species native to the location
- suitability of species to soil type, slope and altitude
- rate of growth of biomass
- potential to meet the biomass requirement of communities
- need for biodiversity conservation

The approach adopted for selecting the species mix is as follows:

- a) Development of separate models for degraded forestland, community land and private land categories
- b) The broad three land categories are further divided into high, medium and low altitude strata
- c) Inclusion of multiple species in each model and for each land category, and for each altitudinal sub-strata
- d) Selection of species for each parcel, jointly by the local community (including GP members and farmers for private land) and the project authorities from a larger basket of species identified for each land category.

The major species proposed for inclusion in the reforestation models are presented in Box A.5.1.

---

<sup>5</sup>NRSA 2005. Wastelands Atlas of India



**PROJECT DESIGN DOCUMENT FORM  
FOR AFFORESTATION AND REFORESTATION PROJECT ACTIVITIES (CDM-AR-PDD) - Version 05**

**Box A.5.1: Species list with local names**

S. No.	Scientific Name	Local Name	English Name
1	<i>Acacia catechu</i>	Khair	Khair
2	<i>Aegle marmelos</i>	Bel	Aegle
3	<i>Aesculus indica</i>	Khanor	Horse Chestnut
4	<i>Ailanthus altissima/A. excelsa</i>	Ailanthus	Ailianthus
5	<i>Albizia procera</i>	Safed Siris	Siris
6	<i>Albizia lebbek</i>	Kala Siris	Siris
7	<i>Albizia stipulata</i>	Ohi	Ohi
8	<i>Alnus nepalensis/A. nitida</i>	Kunish	Alder
9	<i>Azadirachta indica</i>	Neem	Neem
10	<i>Bauhinia variegata</i>	Kachnar	Kachnar
11	<i>Bombax ceiba</i>	Semal	Cottan wood tree
12	<i>Toona ciliata</i>	Toon	Toon
13	<i>Cedrus deodara</i>	Dayar	Deodar
14	<i>Dalbergia sissoo</i>	Tali	Shisham
15	<i>Emblica officinalis</i>	Amla	Amla
16	<i>Gravellia robusta</i>	Silver oak	Silver oak
17	<i>Grewia optiva/G. oppositifolia</i>	Bihul/Dhaman	
18	<i>Juglans regia</i>	Akhrot	Walnut
19	<i>Mangifera indica</i>	Mango	Mango
20	<i>Melia azadirchta</i>	Drek	Drek
21	<i>Morus alba</i>	Shehtoot	Mulberry
22	<i>Pinus roxburghii</i>	Chil	Chir pine
23	<i>Pongamia pinnata</i>	Pongamia	Pongamia
24	<i>Populus ciliata/P. Alba/P. deltoids</i>	Poplar	Poplar
25	<i>Quercus leucotrichophora</i>	Ban	Ban Oak
26	<i>Robinia pseudoacacia</i>	Robinia	Robinia
27	<i>Salix alba</i>	Badha	Willow
28	<i>Sapindus mukorossii</i>	Ritha	Ritha
29	<i>Syzygium cuminii</i>	Jamun	Jamun



**PROJECT DESIGN DOCUMENT FORM  
FOR AFFORESTATION AND REFORESTATION PROJECT ACTIVITIES (CDM-AR-PDD) - Version 05**

30	<i>Terminalia bellerica</i>	Behra	Behra
31	<i>Terminalia arjuna</i>	Arjuna	Arjuna
32	<i>Terminalia chebula</i>	Harar	Harar
33	<i>Artocarpus lakoocha</i>	Dheoun	Dheoun
34	<i>Hicoria carya</i>	Pecanut	Pecanut
35	<i>Dendrocalamus spp</i>	Bans	Bamboo
36	<i>Tectona grandis</i>	Sagwan	Teak
37	<i>Terminalia tomentosa</i>	Sain	Sain/ Alsan
38	<i>Prunus armeniaca</i>	Chuli	Wild Apricot
39	<i>Ulmus laevigata/u. wallichiana.</i>	Marinu	Marinoo
40	<i>Prunus cornuta/P. Cerassoides/P.padus</i>	Paza	Paza
41	<i>Olea glandulifera</i>	Thira	
42	<i>Pinus wallichiana</i>	Kail	Kail
43	<i>Cassia seamia</i>	Cassia	
44	<i>Acacia nilotica</i>	Kikkar	
45	<i>Butea monosperma</i>	Dhak	Dhak

**Box.A 5.2** Species included in the reforestation models for the three land categories

Reforestation model	Altitude	Growth rate	Species mix	Density
Restoration forestry for degraded forest and degraded community lands	High (1400-1800m)	Fast growing	<i>Alnus nitida, Juglans regia, Populus ciliata, Quercus leucotrichophora, Salix alba., Toona ciliata</i>	550
		Slow growing	<i>Ailanthus excelsa altissima, Prunus armenica, Robinia pseudoacacia, Aesculus indica, Cedrus deodara, Pinus wallichiana</i>	550
	Medium (1100-1400m)	Fast growing	<i>Populus ciliata, Salix alba., Tectona grandis, Albizzia procera, Juglans regia, Dendrocalamus strictus., Grevillia robusta, Quercus leucotrichophora, Morus alba, Pinus roxburghii, Toona ciliata, Robinia pseudoacacia, Bombax ceiba, Ulmus laevigata</i>	550
		Slow growing	<i>Ailanthus excelsa, Melia azadirachta, Syzygium cuminii, Bauhinia variegata, Sapindus mukorossii, Mangifera indica, Aegle marmelos, Hicoria carya, Prunus armenica, Pinus wallichiana, Grewia optiva, Cedrus deodara, Robinia pseudoacacia</i>	550
	Low (600-1100m)	Fast growing	<i>Acacia nilotica, Albizzia procera, Bombax ceiba, Dendrocalamus strictus., Dalbergia sissoo, Emblica officinalis, Morus alba, Pongamia pinnata, Populus spp., Salix</i>	550





**PROJECT DESIGN DOCUMENT FORM  
FOR AFFORESTATION AND REFORESTATION PROJECT ACTIVITIES (CDM-AR-PDD) - Version 05**

			<i>alba., Tectona grandis, Toona ciliata</i>	
		Slow growing	<i>Acacia catechu, Aegle marmelos, Azadirchta indica, Bauhinia variegata, Butea monosperma, Cassia siamiae, Grewia optiva, Mangifera indica, Melia azadirchta, Olea glandulifera, Syzygium cuminii, Terminalia arjuna, Terminalia bellerica, Terminalia chebula</i>	550
			<b>Total</b>	<b>1100</b>
Farm forestry for degraded and abandoned private lands	High (1400-1800m)	Fast growing	<i>Alnus nitida, Juglans regia, Populus ciliata, Quercus leucotrichophora, Salix alba., Toona ciliata</i>	660
		Slow growing	<i>Ailanthus excelsa altissima, Prunus armenica, Robinia pseudoacacia, Aesculus indica, Cedrus deodara, Pinus wallichiana</i>	440
	Medium (1100-1400m)	Fast growing	<i>Populus ciliata, Salix alba., Tectona grandis, Albizzia procera, Juglans regia, Dendrocalamus strictus., Grevillia robusta, Quercus leucotrichophora, Morus alba, Pinus roxburghii, Toona ciliata, Robinia pseudoacacia, Bombax ceiba, Ulmus laevigata</i>	660
		Slow growing	<i>Ailanthus excelsa, Melia azadirachta, Syzygium cuminii, Bauhinia variegata, Sapindus mukorossii, Mangifera indica, Aegle marmelos, Hicoria carya, Prunus armenica, Pinus wallichiana, Grewia optiva, Cedrus deodara, Robinia pseudoacacia</i>	440
	Low (600-1100m)	Fast growing	<i>Acacia nilotica, Albizzia procera, Bombax ceiba, Dendrocalamus strictus., Dalbergia sissoo, Emblica officinalis, Morus alba, Pongamia pinnata, Populus spp., Salix alba., Tectona grandis, Toona ciliata</i>	660
		Slow growing	<i>Acacia catechu, Aegle marmelos, Azadirchta indica, Bauhinia variegata, Butea monosperma, Cassia siamiae, Grewia optiva, Mangifera indica, Melia azadirchta, Olea glandulifera, Syzygium cuminii, Terminalia arjuna, Terminalia bellerica, Terminalia chebula</i>	440
			<b>Total</b>	<b>1100</b>

### *Characteristic features of major species<sup>6</sup>*

The characteristic features of major species included in the reforestation models are described below.

*Pinus roxburghii*: The chir pine is a native to the Himalayas. It generally occurs at lower altitudes in the Himalayas, from 500-2000 m, occasionally up to 2300 m. It is a large tree, reaching 30-50 m height with a trunk diameter of upto 2 m. Chir pine is widely planted for timber. It is also occasionally used as an ornamental tree, planted in parks and gardens in hot dry areas, where its heat and drought tolerance is valued. It is also tapped commercially for resin. On distillation, the resin yields an essential oil, commonly known as turpentine and non-volatile resin.

<sup>6</sup> Silviculture of Indian Trees, Vol. I to VI compiled by ICFRE Dehra Dun; Fodder trees of India by Sh. R.V. Singh I.F.S (Retd) and Silviculture of hundred useful trees By Lakshman Singh Khanna IFS (Retd)



**PROJECT DESIGN DOCUMENT FORM  
FOR AFFORESTATION AND REFORESTATION PROJECT ACTIVITIES (CDM-AR-PDD) - Version 05**

*Populus deltoides*: This is a large tree growing upto 20–40 m in height with a trunk diameter of 1.8 m. The tree needs bare soil and full sun for successful germination and establishment in natural conditions. *P. deltoides* tolerates frost, heavy soil, sand, slope, and water logging. It is observed to grow in warm temperate and cold temperate zones. It can be found at an altitude of up to 1000 m, and regions with a mean annual temperature of 8-14°C, and a mean annual rainfall of 600-1500 mm. Poplar is found to persist on infertile sandy, loamy, and clay soils, but thrives best on moist sandy loams or silts close to streams.

*Grewia optiva*: This is a small to medium-sized deciduous tree, 9-12 m in height; crown spreading, bole clear, 3-4 m, and about 1 m diameter. Plants are often cultivated in the Himalayas. This is a tree of the subtropical climate. In its natural habitat, the maximum shade temperature seldom exceeds 38°C and the minimum temperature rarely drops below – 2°C. It tolerates frost during winter. The tree can be found from 0-2000 m altitude and grows on a variety of soils. Propagation is mainly through nursery-raised seedlings or stumps. Pre-sowing treatment of seeds is necessary to hasten and improve germination as the seed is hard. The ripe fruits are edible. The leaves are rated as good fodder. Leaf fodder yield is reported to be 11 ton/ha from 2-year-old plants. Green fodder yield from mature trees is reported to be 12-30 kg per tree. The wood has an unpleasant odour and is, therefore seldom used as fuel, if an alternative is available.

*Azadirachta indica*: Neem is a fast-growing tree that can reach a height of 15-20 m and rarely to 35-40 m. It is an evergreen species but may shed its leaves in response to severe drought. The crown may reach a diameter of 15-20 m. The trunk is relatively short, straight and may reach a diameter of 1.2 m. The bark is hard, fissured or scaly, and whitish-grey to reddish-brown. The neem tree is noted for its drought resistance. Normally it thrives in areas with sub-arid to sub-humid conditions, with an annual rainfall between 400 and 1200 mm. It can grow in regions with an annual rainfall below 400 mm, but in such cases it depends largely on the ground water levels. It can thrive on a variety of temperature and rainfall conditions. It can grow on variety of soils, but thrives best on well-drained deep and sandy soils (pH 6.2-7.0). Neem twigs are used for brushing teeth in India. All parts of the tree (seeds, leaves, flowers and bark) are used in medical preparations. Besides its use in traditional Indian medicine, the neem trees are of great importance for its anti-desertification properties and possibly as a good carbon dioxide sink (<http://neemsources.com/neem.html>).

*Mangifera indica*: Mango is a large evergreen tree growing up to 20 m height with dark green, umbrella-shaped crown with trunk up to 90 cm in diameter. It thrives in both the subtropics and the tropics. In the subtropics, the cold months ensure excellent floral induction, but late frosts are a major risk; tender parts of the tree are killed by frost. In the tropics, the mango grows up to 1200 m elevation, but requires season lasting more than 3 months for fruit production. At elevations above 600 m in the tropics, the climate becomes too cool for the commercial cultivars, and the optimum temperature ranges between 24-27° C. Mango can be grown up to an altitude of 0-1200 m, mean annual temperature of 19-35° C and mean annual rainfall of 500-2500 mm. Mango trees thrive in well-drained soils with pH ranging from 5.5 to 7.5 and are fairly tolerant of alkalinity. Mango is cultivated for fruit. Mango leaves are occasionally fed to cattle. Seed kernel is a by-product of processing and can be used as livestock feed. Mango secretes large quantities of nectar and is an important source of honey. The wood is used as timber for indoor construction, furniture, carpentry, flooring, boxes, crates and boat building (canoes and dugouts).

*Dalbergia sisoo*: It can be raised by (i) direct sowing, (ii) planting out entire plants raised in the nursery, (iii) stump planting, or (iv) planting root suckers. Stump planting however gives better results than planting entire plants, which is better than direct sowing. Ripe pods are collected in December-January,

**PROJECT DESIGN DOCUMENT FORM  
FOR AFFORESTATION AND REFORESTATION PROJECT ACTIVITIES (CDM-AR-PDD) - Version 05**

dried in the sun and broken by beating with sticks. The broken pods or seeds are stored in airtight containers in a dry place. Sowing is done in the nursery beds which are normally 40 cm. wide at base and 30 cm. wide at top and 25 cms. high. The beds are alternated by trenches of 25 cm. width at the base. Sowing is done in February-March where irrigation facilities are available and July under rainfed conditions. Sowing in March should be preferred as low temperature during February delays germination. Broken pieces of pods, each containing one or two seeds, are shown in lines spaced 25 cms apart. In these lines, the broken pieces touch each other. When clean seed is used, the seeds are spaced about 2 cms apart. The seeds or broken pieces of pods are soaked in water for 48 hours before sowing. The optimum depth of sowing is about 1.5 cms. The beds are irrigated soon after sowing. The germination of soaked seeds starts in about a week and is complete in about three weeks. Regular irrigation is necessary for germination and good growth of the seedlings. Two irrigations are needed per week till the completion of germination, one irrigation per week thereafter till the seedlings attain a height of about 10 cms and, from that stage onwards, fortnightly irrigation till the commencement of monsoons rains. During the monsoon season, the nursery beds are irrigated as and when necessary. Hoeing is also done along with weeding to create mulch which helps in moisture conservations. Training of seedlings in the nursery is necessary to avoid overcrowding and completion. The seedlings are spaced 5 cms apart in lines when they attain a height of about 5 cms.

*Albizia procera*: Ripe pods are collected before they dehisce on the tree. These are dried in the sun, beaten and winnowed to get the clean seed which is dried for a few days before storage. For raising nursery stock, the sowing is done in April-May under irrigated conditions. The seed is put in cooling boiled water and allowed to soak for 24 hours to soften the seed coat. Sowing is done in lines about 8 cm. apart and the seedlings are spaced about 5 cm in the lines. About 30 gm. seed is sown per square metre of nursery area. The germination of the treated seed commences in about 3-4 days and takes about 2-3 weeks to complete. Weeding and watering of nursery beds are regularly done. The seedlings raised from April-May sowing attain a height of about 5 cm. by July August when these are planted out in 30 cm<sup>3</sup> pits dug during summer months. Monsoon planting is better than either summer or winter planting. The seedlings taken out from the nursery are planted out either with walls of earth or with naked roots. In the latter case, the lateral roots of the seedlings are pruned and some lower leaves are plucked at the time of planting. Seedlings can also be raised in poly bags for better results. Utmost care is taken to shift the poly bags fortnightly when seedlings attain height of about 20cm to prevent fixing of roots.

*Melia azadirach*: This can be raised either by direct sowing or by planting out nursery raised seedlings or stumps. Fruits are collected during January-February from the trees. They are rubbed and washed to remove the outer pulp. The stones are dried and stored. Sowing is done in nursery beds during February-March in drills 15 cm. apart. Keeping the seed in liquid farm yard manure for about a week is reported to improve germination. The seeds are sown about 2 cm. deep and about 5 cm. apart in the drills. The nursery beds are irrigated after sowing and at regular intervals there after till germination is complete. Germination starts in about three week's time and may take about two months to complete. Each fruit may give rise to as many as four seedlings and at places the seedlings will appear in clumps and will have to be subsequently thinned. Regular weeding of the nursery beds is also necessary as the seedlings are susceptible to weed competition on completion of germination. The seedlings should be thinned to a spacing of about 10 cm. so as to have a spacing of 15x10 cms. The seedlings are transplanted in the nursery beds in July when these are about 2-3 months old. They are retained in the nursery for one more year when they are uprooted for planting out. The seedlings are planted out either in July or during winter months when these are leafless. For planting out entire plants in July, the seedlings are uprooted from the nursery with walls of earth. Planting is done in 30 cm<sup>3</sup> pits dug in advance. Stumps are prepared from 15 months old seedlings and are planted in 30 cm<sup>3</sup> pits in the same manner as entire plants.



**PROJECT DESIGN DOCUMENT FORM  
FOR AFFORESTATION AND REFORESTATION PROJECT ACTIVITIES (CDM-AR-PDD) - Version 05**

*Aesculus indica*: It is a large size deciduous tree found in western Himalayas from 1500- 3000 meter altitude in depressions and along nallas. Aesculus can be raised by direct sowing. Ripe fruit is collected during October-November and sown in patches during December. About 4-6 seeds are sown/patch. Germination starts in March-April. At the end of one season, only one best grown plant is retained in a patch and remaining ones be safely cut. Regular weeding of patches is done during first year. Nursery raised seedling can also be used for better results. It can be raised in nursery either in beds or in poly bags. The seeds are sown in raised beds before snow fall in Nov-Dec at a distance of 10cm from seed to seed and 22 cm apart from the line. The beds are covered by thin layer of grass. Watering is done as and when required. Germination starts in March and is completed within month. Weeding is done regularly. Seedlings are planted out during winter after one year. Seedlings can also be raised in the containers. Finely pulverised soil mixed with compost is filled in the containers. One seed is sown per container. Container grown seedlings are planted out in the same way as nursery grown seedlings.

*Alnus nitida*: Alnus can be raised either by direct sowing or by nursery raised seedlings. Seeds are collected during October-November rubbed and washed to get the seed which is dried in shade. Seed can also be separated by winnowing lightly. For direct sowing, the seed is mixed in fresh cow dung and then the cow dung mixed with seed and diluted with some water is broadcast over the area in thin layers during winter (December-January). This method is useful particularly in case of land slips. The seeds germinate during March-April and plants soon take possession of the ground. For nursery raised plants, the seed is mixed with some soil and sown in nursery beds in lines 22cm. apart. There is no need to further cover the seed by soil since seed is very small. Sowing is done during December. The nursery should be located in planting zone. Germination starts in March-April. Regular watering be done in drier months. Weeding too is necessary when plants become 10-15cm. high. These are spaced out about 10-15cms. The weak seedlings are uprooted from lines with care and well grown seedlings are retained at a spacing of 15-20 cms. Plants will be ready for planting during winter when about 8-9 months old. Planting be done preferably in 45 cm. pits, naked root.

*Juglans regia*: It is a large sized deciduous tree found from 990 -3000 meter altitude in western Himalayas. It is found mixed with other Broad leaved species along depressions in wild. Walnut is also found cultivated by the farmers along their field and adjoining habitations. Seeds are collected during October-November and sown in nursery beds either during December before snow fall or during March just after snow melting. Spacing is kept 10 cm. from seed to seed and 22 cm. from line to line. Seeds germinate after snow melting and germination completes within a month. Regular watering is done to beds. Weeding too is necessary but care be taken not to disturb the plant. Plants are planted naked root in the field during the next winter when these are about twenty one months old. In case plants develop long taproot, then the taproot portion is cut to size so as to accommodate it in 45 cm. size pit. Planting should not be done during monsoons rains.

*Ailanthus excelsa*: This is a large deciduous tree, 18-25 m tall with straight trunk, 60-80 cm in diameter; light grey to grey brown bark. The tree is native to central, western and southern India, but is now being spread to other semi-arid and subtropical areas. *A. excelsa* grows well in semi-arid and semi-moist regions and has been found suitable for planting in dry areas with annual rainfall of about 400 mm. It is commonly found in mixed deciduous forests and some sal forests, but is rare in moist areas with high monsoons. Plant associations include *Acacia catechu*, *A. leucophloea* and *Azadirachta indica*. It is a relatively salt-tolerant species. The tree can be grown at an altitude range of up to 900 m and tolerates a mean annual temperature of 0-45° C and a mean annual rainfall of 500-2500 mm. It can be grown on a variety of soils, but thrives best in porous sandy loams. Natural regeneration occurs through seed and



**PROJECT DESIGN DOCUMENT FORM  
FOR AFFORESTATION AND REFORESTATION PROJECT ACTIVITIES (CDM-AR-PDD) - Version 05**

coppice. Seedling regeneration is generally scanty and cannot be relied upon to regenerate natural stands. Natural regeneration through coppice and root suckers is adequate as long as trees harvested are healthy. Artificial regeneration is through direct seeding or planting pre-germinated seed. Leaves are lopped for use as sheep fodder. The wood is used as fuelwood. It can also be used as timber but is perishable and is subject to insect attack and stain. The bark yields a gum of inferior quality.

*Acer pictum*: This tree is generally found in western Himalayas from 1800 meter to 2500 meter altitude but some time it also found down to 1200 meter altitude. It is natural species of temperate parkland and is a colonizer. It is found in variety of soils but thrives well in sandy loamy deep soil. It is a light demander but in the younger stage it can also tolerate shade. It is frost hardy also coppices well in open. Seeds ripen during July to October. One gram of seeds contains about 12 seeds. The fruits are collected from September to October. The fruits are dried in the sun and seeds are extracted by beating the dried fruits. Acer can be regenerated either by entire planting or by stump planting. The seeds are sown in the raised beds in the nursery during November – December before the snowfall and can also be sown during March after the melting of snow. Spacing is kept 10 cm from seed to seed and 22 cm from line to line. The germination starts in March and is completed by April. It can also be raised in poly bags. Watering and weeding is done as and when required. During the next winter, seedlings are transplanted at a distance of 15 cm from line to line. In case seedlings develop long tap root, then the taproot portion is cut to size so as to accommodate it in the transplanting bed. In the next winter season it can be planted as naked root in 45 cm size pit. The plant with less than 1.5 cm collar diameters should not be planted. The seedling raised in the Poly bag can be planted after one year. It is a fairly fast growing species and its wood is used for carving, furniture and preparation of rifles butts etc.

*Hicoria carya*: It is a medium size deciduous tree found up to 1800 meter altitude in western Himalaya generally in warmer locations. It is a very important nut and has very high demands for its nuts. It is a light demander with very deep root system. It thrives in all types of soil but attains very good growth in sandy loamy soil. It can be grown either by directly sowing in the field or by nursery raised seedlings. The latter gives better results. However, in both cases survival percentage is not good. Seeds are collected during September or October and are sown in the nursery beds either during December or March. It can also be raised in the poly bags filled up with loamy soil mixed with one third farm yard manure. Sandy/ clayey soil may be avoided for filling the polythene bags. Since it can be planted as naked root therefore for better result, seed sown directly in the beds can be given preference. In the raised nursery beds generally spacing is kept 10 cm from seed to seed and 22 cm from line to line. Seeds starts germinating in March and germination completes within a month. Regular watering is done in the beds. Weeding is done as and when required but care should be taken not to disturb the plant. Plants are planted with naked root in the field during the next winter when they are about twenty one months old having collar diameter more than 2cm. and height of 45cms. In case plants develop long tap root then the taproot portion is cut to size so as to accommodate it in 45cm size pit. Planting should not be done during monsoon rains.

*Cedrela serrata*: It is a medium size deciduous tree found in western Himalayas above 1800 meter altitude. Sometimes it also occurs below 1800 meter in depressions along *nallas*. It is a shade bearer and frost hardy. It can be grown either directly sowing in the field or by nursery raised seedlings. The latter gives better results. The ripe fruits are collected during June from the trees before opening. The fruits should be collected when they start turning yellow and a few of them commence to open. These are dried, rubbed and winnowed to get the clean seed. Sowing is done in June –July and August. The seed is sown in raised nursery beds in lines about 20 cm apart and should be only lightly covered by fine soil or sand and should in no case be sown deep. The beds should be covered by thin layers of dry grass to

**PROJECT DESIGN DOCUMENT FORM  
FOR AFFORESTATION AND REFORESTATION PROJECT ACTIVITIES (CDM-AR-PDD) - Version 05**

prevent the washing away of the seeds. The seedling can also be raised in Poly bags of bigger size. Germination commences in about a week and continues for another week. The grass is removed after germination starts. The nursery beds are shaded to protect the young seedlings from the hot sun. Water logging has to be avoided. About 5-8 cm tall seedlings are transplanted in nursery beds at spacing of about 15x15 cm. Regular weeding is necessary. Watering should also be regularly done after monsoon rains cease. The seedlings raised in Poly bags need to be shifted after fortnight to avoid roots fixation. The seedlings are planted out either during winter as naked root when they are leafless or during the following July- August when raised in poly bags. Planting out is done in monsoon season in pits of about 45cm<sup>3</sup> at a spacing of 3x3 or 4x4 m. Planting should preferably be completed before the 1<sup>st</sup> week of August for better result.

*Grewelia robusta*: It is an exotic species to India. It is a native plant of Australia but is grown in India as avenue plantations since time immemorial. It can be grown in a variety of climatic conditions. It thrives well in deep loamy soil but can also be grown in refractory mining areas as well. It is generally a light demander but requires shade during early stages. It is a frost and drought hardy. The ripe fruits are collected from the trees before opening during November and December. One gram contains 95-105 seeds. The fruits are dried, rubbed and winnowed to get clean seed. Sowing is done in October or February. The seed is sown in raised nursery beds in lines about 8-10 cm apart and should be lightly covered by soil or sand. Ash can also be mixed with seeds for its uniform distribution during the sowing. After sowing, the bed is covered by a thin layer of dry grass to prevent washing away of the seed. The grass is removed after germination starts. Watering is done twice a day by using small size rose of watering can or by atomizer. During summer shade can also be provided to protect the young seedlings from the hot sun. About 8-10 cm tall seedlings are transplanted in nursery beds or in Poly bags. The seed can also be sown directly in the Poly bags for better results. Since it is fast growing, the seedlings raised in Poly bags need to be shifted fortnightly to prevent root sticking. Planting out is done in monsoon season in pits of about 45cm<sup>3</sup> at a spacing of 3x3 or 4x4 m. Planting should preferably be completed before the 1<sup>st</sup> week of August for better result.

*Aegle marmelos*: Aegle marmelos is a slow-growing, medium sized tree, up to 12-15 m tall with short trunk. It is cultivated throughout India, mainly in temple gardens, because of its status as a sacred tree. The tree grows wild in dry forests on hills and plains. It is a subtropical species. In the H.P. it grows up to an altitude of 1,200 m where the temperature rises to 48.89° C in the shade in summer and descends to - 6.67° C in the winter, and prolonged droughts occur. It is said to do best on rich, well-drained soil. It is commonly grown from seed in nurseries and transplanted into the field. Flowering occurs in April and May soon after the new leaves appear and the fruit ripens in 10 to 11 months from bloom – March to June of the following year. Seeds are sown in Poly bags either in June or in March. Germination starts within a week and may take about two weeks to complete. Regular weeding is done. The seedlings are retained in the nursery for one to one and half year when they are finally ready for planting out in the field. The seedlings are planted out in July. Planting is done in 45cm<sup>3</sup> pits dug in advance. The tree has no exacting cultural requirements, doing well with minimum care. The spacing in the orchards is kept about 6-9 m between trees. Seedlings begin to bear in 6 to 7 years, vegetatively propagated trees in 5 years. Full production is reached in 15 years. Normally, the fruit is harvested when yellowish-green and kept for 8 days while it loses its green tint. Then the stem readily separates from the fruit. A tree may yield as many as 800 fruits in a season but an average crop is 150 to 200, or, in the better cultivars, up to 400.

*Artocarpus lakoocha*: It is a valuable tropical tree species native to India and used for fruit, furniture, timber, and feed. The lakoocha fruits are generally eaten fresh. Each fruit contains 20–30 seeds that are

**PROJECT DESIGN DOCUMENT FORM  
FOR AFFORESTATION AND REFORESTATION PROJECT ACTIVITIES (CDM-AR-PDD) - Version 05**

fleshy with thin seed coat. The edible fruit pulp is believed to act as a tonic for the liver. Raw fruits and male flower spike (acidic and astringent) are utilized in pickles and chutney (sauce). The lakoocha tree is also valued for feed and timber. The hardwood sold as lakuch, is comparable to famous teak wood. Lakuch which is durable outdoors as well as under water is used for construction, furniture, boat making, and cabinet work. The orange-yellow male flowers and reddish female flowers of lakoocha are borne separately on the same trees. Fruits are nearly round or irregular, from 5 to 12 cm in diameter and have a velvety surface. The lakoocha fruits are dull-yellow with pink tinge and sweet-sour pulp. Fruit yield can be up to 80 kg/tree with fruit weight ranging from 200 to 350 g. The lakoocha is popularly known as “monkey jack” or “lakuchi” in India. A native of the humid sub-Himalayan regions of India, it grows up to 1,200 m altitude. The lakoocha trees grow 6 to 9 m tall with large, leathery and deciduous leaves. There are a number of important problems associated with regeneration and propagation of lakoocha: (1) tree population of lakoocha is gradually decreasing due to poor seed viability and extensive exploitation for food, timber, and other uses; (2) seeds, once extracted from the fruit, quickly lose viability within a week, or sometimes even in few days; and (3) vegetative propagation methods such as rooting of hardwood or softwood stem cuttings have not been successful (Napier and Robbins 1989). Lakoocha fruits were collected just before maturity and stored at 4°C. Fruits were washed under running tap water for 1 hr, then washed with detergent and rinsed 3 times with sterile distilled water. Fruits were dipped in 70% ethanol for 1 minute, air dried and flamed to evaporate ethanol. Following this, fruits are cut open to remove the seeds. Air dried seeds are germinated on sterile sand and are thereafter transplanted into Poly bags. These are kept in nursery for about one year. Regular weeding and watering is done. The planting is done in 45cm<sup>3</sup> pit dug in advance in rainy season.

*Pistacia integerimma*: It is found at the height of 1200 to 8000 feet and attains a height of 9 meter. The bark is of light brown colour. Flowers are small and are of red colour. Fruits are shiny, round and 1/4 inch in diameter. The fruits become brown in colour. The fruit arises in early summers and is followed by fruiting. It is a deciduous tree growing to 9 m height. The flowers are dioecious (individual flowers are either male or female, but only one sex is to be found on any one plant so both male and female plants must be grown if seed is required. The plant prefers light (sandy), medium (loamy) and heavy (clay) soils. It can grow in semi-shade (light woodland) or no shade. It requires dry or moist soil. It requires a sunny position in a deep well-drained light soil. Plants are prone to fungal root rots. Any pruning that needs to be done is best carried out in the spring. Dioecious, male and female plants must be grown if seed is required. Pre-soak the seed for 16 hours in alkalized water, or for 3 - 4 days in warm water, and sow during late winter in a cold frame or greenhouse. Two months cold stratification may speed up germination, so it might be better to sow the seed in early winter. The germination is variable and can be slow. Prick out the seedlings into the poly bags when they are large enough to handle and grow on the plants for at least their first winter in a greenhouse. Plant out into their permanent positions in early rainy season and consider giving some protection from winter cold for their first year or two outdoors.

*Artocarpus heterophyllus*: *Artocarpus heterophyllus* occurs in the moist forests up to an elevation of about 1,200m. It is cultivated as a fruit, shade or ornamental tree throughout the country. It is a tree of moist tropical climate, but has been cultivated with success even in drier and cooler climates. In areas with less than 1250 mm rain, irrigation is essential for its good growth. It is capable of growing on a variety of soils, but requires a deep rich soil for optimum growth. *Artocarpus heterophyllus* can stand some shade in the seedling and sapling stages, but requires complete overhead light for its optimum growth in later stages. The seedlings are sensitive to frost and drought. It can be raised either by direct sowing or by planting out container raised seedlings. Ripe fruits are collected and cut open for seed extraction. The seeds are dried in the shade. About 45 to 90 seeds weigh one kilogram. The seeds are oily and soon lose their vitality. Storage of seed for long periods is not possible under ordinary conditions, but



**PROJECT DESIGN DOCUMENT FORM  
FOR AFFORESTATION AND REFORESTATION PROJECT ACTIVITIES (CDM-AR-PDD) - Version 05**

it can be done in a pit covered with about 5 cm of dry earth. Seedlings can be raised in polythene bags filled with well pulverised soil mixed with compost. Sowing is done in July and two seeds are sown in each container. Fresh seed, which should be used, gives a germination percentage of about 75. In the containers in which both the seeds germinate, one seedling should be clipped. The seedlings need protection against hot sun. The containers should be regularly watered as the seedlings are very sensitive to drought. One year old seedlings can be planted. Planting is done in July after the commencement of monsoon rains. Plants with soil column intact are planted in 30 cm<sup>3</sup> pits. Spacing may be about 5x5m. Plantation areas need protection against fire and browsers.

*Pongamia pinnata*: *Pongamia pinnata* is almost an evergreen tree except in dry localities where it becomes leafless for a short period in May. It can grow on a wide variety of soils, ranging from sandy to black cotton soils, but it grows best on deep and well drained alluvial soils with abundant supply of soil moisture. *Pongamia pinnata* can be raised by direct sowing or by planting out of entire plants or stumps. The pods are generally collected from December to May; the time of collection in different parts of the country differs according to the climate. The pods are dried in the sun and thrashed to separate the seed which is dried in shade before storage. About 1,200 to 1,500 seeds weigh one kilogram. The seed retains its vitality at least for a year, if carefully stored. Sowing in the nursery is done in June-July. Seeds are sown in drills 15 cm apart and at a depth of about 2 cm. Soaking of the seeds in the cold water for 24 hours before sowing hastens and improves germination, however, reported that cold or hot water treatment to the seeds does not improve germination. Germination starts in about 10 days and takes about a month to complete even though a few seeds may be seen germinating even up to 10 weeks. The percentage of fertility is high and germination percentage of about 60 to 80 can be expected. Seedlings can also be raised in the Poly bags. Finely pulverised soil mixed with compost is filled in the Poly bags. One seed is sown per Poly bag. Seedlings raised in Poly bags are planted out in the same way as nursery grown seedlings. Planting is done in July-August. One year old seedlings, which attain a height of about 50-60 cm, are planted out. Entire plants or stumps may be used for planting; the use of the latter is more convenient for large scale plantation work. For making into stumps, plants of about 1-2.0 cm collar diameter are preferred.

*Syzygium cuminii*: *Syzygium cuminii* prefers clayey loam soil though it is found growing on a wide variety of soils. Along river beds, it grows on alluvial sandy soils where its moisture requirement is met from stream water or from water seeping into river beds from adjoining areas. *Syzygium cuminii* is a shade bearer. The saplings and poles can withstand moderate shade of its bigger trees or other trees. Though the trees are fairly resistant to drought, the seedlings are very sensitive to it and are often killed when exposed to direct sun during dry periods. The seedlings and saplings are frost tender, but the trees can withstand frost well. It has good coppicing power and a large number of coppice shoots arise along the periphery of the cut stump. Ripe fruits are collected from the trees or are swept from the floor. Fruits damaged by birds, monkeys or rodents are rejected. The flesh is rubbed off to separate out the stones which are washed and dried in shade. About 1,100 to 1,300 stones weigh one kilogram. When stored, the seed loses vitality quickly and as such fresh seed is used for sowing. Sowing in the nursery beds is done in June-July. Seed from only fresh collection is used. Depth of sowing is usually 2 to 2.5 cm. Irrigation is regularly done after the monsoon rains cease and also during winter months. Seedlings can also be raised in the containers. Finely pulverised soil mixed with compost is filled in the containers. One seed is sown per container. Container grown seedlings are planted out in the same way as nursery grown seedlings. Planting out of entire plants or stumps is done in July-August. Planting should preferably be completed in July as late planting gives poor survival. For stump planting, the stumps are prepared from 2 or 3 year old plants depending upon their growth. Stumps varying from about 0.8 to 2.0 cm collar diameter are found to perform similarly so far as the survival and growth of the resultant plants are





**PROJECT DESIGN DOCUMENT FORM  
FOR AFFORESTATION AND REFORESTATION PROJECT ACTIVITIES (CDM-AR-PDD) - Version 05**

concerned. The stumps are prepared from healthy well grown plants in the usual manner. Stumps should be planted out as quickly as possible after their preparation.

*Bombax ceiba*: *Bombax ceiba* grows in regions experiencing wide range of temperature and rainfall, but it thrives best in a comparatively moist tropical climate; in its natural habitat (excluding the outer range of Himalayas) the absolute maximum shade temperature varies from about 35° to 49° C, the absolute minimum temperature from about – 4° to 18° C and the normal annual rainfall from about 750 to 4,500mm. The soils on which *Bombax ceiba* grows are also variable. In the sub-Himalayan tract, it grows chiefly on alluvial soil along stream banks, where it tends to be gregarious. On hill slopes, the soil is shallow, sandy loam or gravelly and often dries during hot season. *Bombax ceiba* is a strong light demander, drought resistant, and fairly resistant to frost though severe frosts may kill the shoots of seedlings; it coppices in early years, but not later. The sapling and poles get killed by fire, but they recover from such injury. *Bombax ceiba* can be raised either by direct sowing or by planting out nursery raised seedlings. Planting of stumps prepared out of 1-2 year old plants is better than the above two methods. For seed collection, ripe fruits are collected from the trees before they open. To avoid collection of unripe seed, the fruits should not be collected before a few of them start to open. The fruits are spread in the sun to open and to release the seeds with cotton. During sun drying the capsules should be covered by a wire mesh so that the released seeds are not blown away by wind. One hundred capsules (dry) weigh about 2 kg and yield about 570 g of floss and 450g of seed. About 214-385 clean seeds weigh one gram. Fresh seed shows high fertility and gives an average germination percentage of 82. For raising nursery stock, sowing is done from May to July depending upon weather the nursery is irrigated or not; sowing in irrigated nurseries is done in May and in rain-fed nurseries in July. The seed is sown in lines about 15 cm apart if transplanting is to be done and about 25 cm apart if transplanting is not to be done. Regular weeding of nursery beds is necessary. If transplanting is not to be done, the seedlings should be spaced about 20 cm in lines when these are about two months old. In nurseries where transplanting is done, about two months old seedlings are transplanted at a spacing of about 25x20 cm. Seedlings can also be raised in the containers. Finely pulverised soil mixed with compost is filled in the containers. One seed is sown per container. Container grown seedlings are planted out in the same way as nursery grown seedlings.

**A.5.4. Technology to be employed by the proposed A/R CDM project activity:**

The technology measures and improved practices implemented or proposed to be implemented in various phases of the project are outlined below.

***Identification of lands suitable for the project***

The project utilizes remote sensing maps, participatory rural appraisal techniques, and geo-referenced data on discrete areas to identify lands suitable for the project. The data are organized using a geographic information system database.

***Fencing of the project area***

The fencing is carried out using fence posts of wood, bamboo, and stone. The wood posts are sourced from lops and tops of trees in adjoining forests and plantations, which are periodically pollarded as a traditional silvicultural practice. Bamboo fencing will be encouraged and will be adopted wherever possible. Bamboo poles extraction will be carried out in a sustainable manner. Normally about 60 poles are used per ha for fencing. Of the total project area of 4003.06 ha, only 50% of the total area may require fencing while the remaining may not require fencing, since these plots are away from the



**PROJECT DESIGN DOCUMENT FORM  
FOR AFFORESTATION AND REFORESTATION PROJECT ACTIVITIES (CDM-AR-PDD) - Version 05**

settlements. Wood posts will be used in 50% of area and bamboo fencing in the remaining area. Fencing is normally carried out one year prior to planting.

***Seed collection***

High quality seeds will be selected from the forest and plantation sources for raising seedlings. The seeds will be selected from good trees identified for seed collection. The seeds collected will be tested for their germination ability and growth in the nurseries.

***Nursery technology***

Decentralized nurseries will be established in different watershed divisions and even at panchayat level. Decentralized nurseries would reduce the transportation cost as well as the vehicular emissions. Species will be raised in the nursery for a period of 12 to 18 months as opposed to maintenance of seedlings for 4-9 months, which is traditionally followed. All the nursery activities will be carried out using manual labour. Nursery raising activity will be initiated during March-April of each year. The seedlings to be planted would be graded following the standards adopted by the state forest department. The seedlings raised in the nurseries will be transported to land parcels for planting. To ensure better survival of plants, sturdy and profuse root system is required. The nursery techniques to be used for production of healthy nursery stock include:

- Root trainers to prevent coiling of seedling root system
- Better medium for growth of seedlings
- Use of organic manure / Vermi Compost in appropriate proportions

***Site preparation***

This involves clearing of weeds from an area of about 0.06 m<sup>2</sup> for each seedling and digging pits of 45x45x45cm. Traditionally pit size adopted for all species is 30x30x30cm. Clearing of existing shrubs and weeds will be restricted to only the pit area of the seedling (0.06 m<sup>2</sup> per pit). The plants in the remaining area will not be disturbed. The total area to be disturbed at per hectare will be insignificant at around 70 m<sup>2</sup>/ha (0.007% of area to be planted). This helps to protect the soil and moisture as well as reduce emissions of greenhouse gases due to burning. Disturbance of top soil will be insignificant, to avoid oxidation of soil organic matter. Slash and burn practice will not be used in the project area to avoid the emissions of greenhouse gases. All land preparation activities will be carried out using manual labour. Further, tractors and machinery cannot be used due to sloping topography of the land. Pit digging will be carried out from February to March.

***Planting***

Planting will be carried out during monsoon months (July-Aug and Nov-Dec). The replacement planting will be carried out to replace the failed seedlings during the second and third year after planting. Normally, about 25% will be replaced during first replacement and 10% subsequently, depending on the mortality of the planted seedlings.

***Fertilizer and manure application***

It is proposed not to apply both organic and inorganic fertilizer to the plants. This is not traditionally practiced in the reforestation programmes in Himachal Pradesh.

***Multiple-storied and multispecies plantations***



**PROJECT DESIGN DOCUMENT FORM  
FOR AFFORESTATION AND REFORESTATION PROJECT ACTIVITIES (CDM-AR-PDD) - Version 05**

A wide range of species will be mixed in the plantations making maximum use of solar energy and communities' requirements like fast growing, timber yielding, fodder yielding, fruit yielding, etc. This is not the case in traditional departmental reforestation activities.

***Weeding and cultural practices***

Weeding around the planted seedling will be carried out manually to reduce the competition with the planted seedlings. Manual weeding is done twice a year for 5 years during September and February. Cultural operations will not involve disturbance of top soil.

***Tending, thinning and harvesting operations***

The silvicultural operations such as tending, pruning, thinning and harvesting will be carried out using forestry techniques recommended by the state forest department. Silvicultural practices will be carried out with human labour so as to meet the objectives of employment generation for local communities.

The site preparation, pitting, planting and other silvicultural practices will not vary across different models or strata.

**A.5.5. Transfer of technology/know-how, if applicable:**

Not applicable

<p><b>A.6. Description of legal title to the land, current land tenure and rights to <u>tCERs/ICERs</u> issued for the proposed <u>A/R CDM project activity</u>:</b></p>
--

>>

The Indian Forest Act of 1927 defines three classes of Government forests – Reserved Forests, Village Forests and Protected Forests.

***Degraded forestland:*** This category is delineated from the existing reserved/protected forests and is defined as undemarcated forest. This land category is owned and controlled by the State Forest Department. However, the communities have a right of access to some of the identified forest products. According to the laws, felling of trees in these lands is banned as governed by the forest conservation policies, laws and regulations (Indian Forest Act of 1927, Forest Conservation Act of 1980, MFP Acts, Timber for Dwelling rights). Conversion of this land for non-forestry purposes such as agriculture or infrastructure development is banned.

***Degraded community land:*** This category includes protected forests declared under 1952 notification; and village common land managed by communities through the Panchayat Raj Institution system or other village level institutions, in harmony with the provisions of the Participatory Forest Management rules. Conversion of this land category for non-forestry purposes such as agriculture or infrastructure is banned.

***Degraded and abandoned private land:*** These lands are owned and managed by individual farmers, often inherited or encroached long ago. These lands have been left fallow due to lack of resources or their unsuitability for crop production.

The details of the legal title to the land, current land tenure and rights to CERs for the proposed A/R CDM project activity are presented in Table A.6.1.



**PROJECT DESIGN DOCUMENT FORM  
FOR AFFORESTATION AND REFORESTATION PROJECT ACTIVITIES (CDM-AR-PDD) - Version 05**

**Table A.6.1:** Tenure and rights of access to CERs

Land category	Legal title / land tenure	Use & rights for CERs
Degraded forestland	Forest Department, Govt. of Himachal Pradesh	Full transfer of CER revenue from the Forest Department to local communities permitted as per the pre-project agreement.
Degraded community land	Forest Department/Revenue Department, Govt. of Himachal Pradesh	Full transfer of CER revenue from Revenue and Forest Departments to local communities permitted as per the pre-project agreement.
Degraded and abandoned private land	Individual farmer	Individual farmer to have full rights over CER revenue

<b>A.7. Assessment of the <u>eligibility of the land</u>:</b>
---

&gt;&gt;

The Government of India defines ‘forest’ as land having growing trees with:

- A minimum area of 0.05 ha,
- A minimum tree crown cover of 15%, and
- A minimum height of 2 meters.

The land selected for the project is below the national threshold of forest (crown cover, tree height and minimum land area) for forest definition under decisions 11/CP.7 and 19/CP.9 as communicated by the respective DNA.

This definition of forest by the Government of India complies with the UNFCCC definition. Further, the A/R CDM project activities considered for the project comply with the definition of reforestation.

Land eligibility is established according to the AR eligibility tool Version 01 “*Procedures to define the eligibility of land for afforestation and reforestation project activities*”<sup>7</sup>, approved by the CDM Executive Board. The following two methods were adopted to prove the eligibility of land.

1. *Satellite imagery for the project GPs for the period 1988/89:* Remote sensing maps of 1:50,000 scale were obtained from Forest Survey of India for the period 1988/89, which indicated that the land parcels or polygons considered for the project had tree crown cover less than 10% (FSI provided vegetation cover classification for below 10%, 10-40% and >40% crown). Sample maps are provided for a selected division (and GPs) in Figure A.6.1. Similar maps for all project GPs are available. All the project land parcels selected had a tree crown of <10%, even though Government of India has adopted a tree crown of 15% as part of the definition of forest. Vegetation survey was conducted in 64 sample parcels extending over 42 randomly selected GPs belonging to different watershed divisions. *GPS survey of all the parcels of land was conducted to generate boundaries and measure area.*
  - Details of land cover and features around the identified parcel of land are recorded in a form
    - Point locations of the land parcels were downloaded to give a point vector coverage
    - Point coverage showing central points of the parcels were then overlaid on the remote sensing data

<sup>7</sup>[http://cdm.unfccc.int/EB/Meetings/035/eb35\\_repan18.pdf](http://cdm.unfccc.int/EB/Meetings/035/eb35_repan18.pdf)

**PROJECT DESIGN DOCUMENT FORM  
FOR AFFORESTATION AND REFORESTATION PROJECT ACTIVITIES (CDM-AR-PDD) - Version 05**

- Details recorded on the field forms were then used to delineate the identified parcels of the land on the remote sensing data by on-screen digitization of the polygons
  - Once the land parcels were delineated on the satellite image, suitable maps of the same on a scale of 1:10,000 showing high resolution satellite image in the background was generated to facilitate demarcation of the land on the ground
2. *Ground based survey and PRA:* The project authorities visited each of the selected GPs to verify the presence or absence of forests in 2006. This was done using cadastral maps where the polygons included in the project area were verified on the ground through Participatory Rural Appraisal.

“Reforestation” is the direct human-induced conversion of non-forested land to forested land through planting, seeding and /or the human induced promotion of natural seed sources, on land that was forested, but that has been converted to non-forested land. The reforestation activities will be limited to reforestation occurring on those land that did not contain forest on 31 December, 1989.

The lands to be planted in the proposed A/R CDM project are degraded unclassified forestlands and degraded community lands, which have very low tree or no tree cover below the threshold of the forest and similarly degraded abandoned private lands have tree cover below the threshold, and have been left fallow for long periods as demonstrated during PRA exercise. The land is not temporarily unstocked as a result of human intervention such as harvesting or natural causes or is not covered by young natural stands or plantations which have yet to reach a crown density or tree height in accordance with national thresholds and which have the potential to revert to forest without human intervention.

Therefore the land for the proposed A/R CDM project activities comply with the definition for reforestation defined by decision 11/CP.7 as described below. Further, all the project activities proposed to be implemented on the different land categories will lead to the conditions meeting the definition of forest within the timeframe of the project period, with planting of 1100 seedlings/ha.

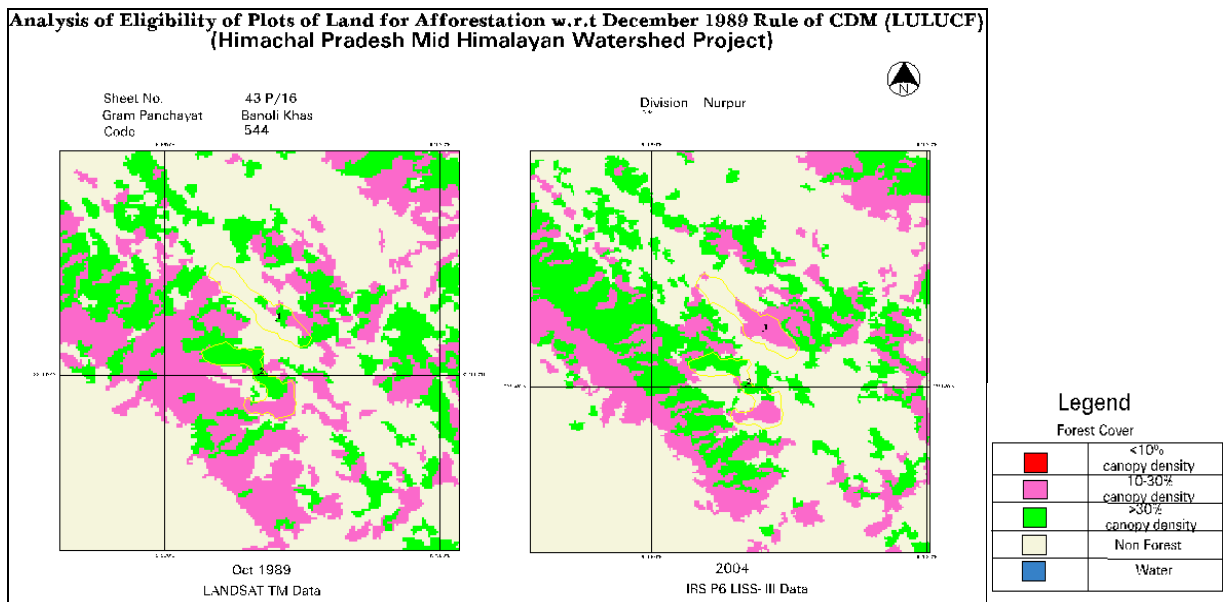

**Figure A.6.1: Sample remote sensing map for selected GP**

**PROJECT DESIGN DOCUMENT FORM  
FOR AFFORESTATION AND REFORESTATION PROJECT ACTIVITIES (CDM-AR-PDD) - Version 05**

The remote sensing maps obtained for 1989/90 and 2005 clearly indicate that the land parcels selected for the project activities had <15% tree crown. This indicates that the land parcels selected were not forests on 31<sup>st</sup> December 1989, and subsequently as per the latest remote sensing assessments.

**A.8. Approach for addressing non-permanence:**

&gt;&gt;

In accordance with paragraph 38 and section K of the CDM A/R modalities and procedures<sup>8</sup>, the following approach is selected to address non-permanence of the A/R CDM activity: ‘Issuance of tCERs for the net anthropogenic greenhouse gas removals by sinks achieved by the project activity during each verification period, in accordance with paragraphs 45–50 of the CDM A/R modalities and procedures in ‘Decision -/CMP.1 - Modalities and procedures for afforestation and reforestation project activities under the clean development mechanism in the first commitment period of the Kyoto Protocol’.

Issuance of tCER for the net anthropogenic GHG removals by sinks achieved by the proposed A/R CDM project activity is adopted. Some sequestered carbon may be released from individual parcels of land due to unexpected fires, pest or other catastrophic events. In this case, an equivalent quantity of tCERs shall be replaced based on modalities and procedures of A/R CDM project activities.

There will be no coincidence of monitoring with peaks in carbon stocks. The stand models consist of multi-species, a combination of slow and fast growing species. Evidence available for six species shows that firstly, there are no cyclic peaks (Figure A.8.1). Secondly, most species have long rotation and thirdly, the growth rates vary from species to species within a stand model and each stand model has several tree species (refer to Box A.5.1).

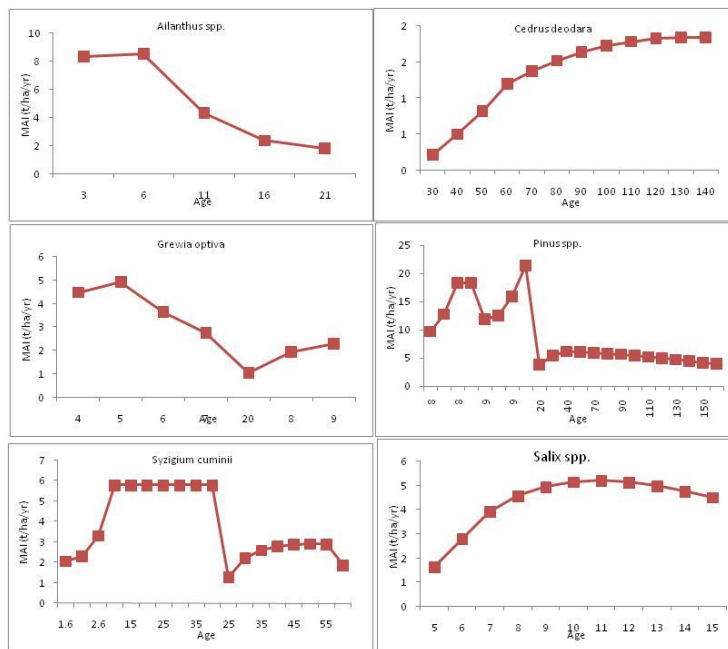

**Figure A.8.1:** Growth rates of different species over different age classes

<sup>8</sup> Decision -/CMP.1 - Modalities and procedures for afforestation and reforestation project activities under the clean development mechanism in the first commitment period of the Kyoto Protocol.



**A.9. Estimated amount of net anthropogenic GHG removals by sinks over the chosen crediting period:**

>>

Annual net anthropogenic GHG removals by sinks are assessed by estimating the annual average actual net GHG removals by sinks due to project activities and deducting the annual average net baseline GHG removals by sinks and annual leakage emissions. The cumulative net anthropogenic emissions for the project are the sum of the annual net anthropogenic GHG removals by sinks over the crediting period of the project. However, since leakage accounts for less than 5% of the actual net GHG removals by sinks, it is excluded. The total cumulative net anthropogenic GHG removal by sinks due to project activities, excluding leakage is estimated to be 828,016 tCO<sub>2</sub>-e. The overall average net anthropogenic GHG removals by sinks, excluding leakage is 207 tCO<sub>2</sub>-e per ha and 10.34 tCO<sub>2</sub>-e per ha/year.

Summary of results obtained in Sections C.7., D.1., and D.2.				
Year	Estimation of baseline net GHG removals by sinks (tonnes of CO <sub>2</sub> e)	Estimation of actual net GHG removals by sinks (tonnes of CO <sub>2</sub> e)	Estimation of leakage (tonnes of CO <sub>2</sub> e)	Estimation of net anthropogenic GHG removals by sinks (tonnes of CO <sub>2</sub> e)
2,006	-	1,738	-	1,738
2,007	-	5,493	-	5,493
2,008	-	14,925	-	14,925
2,009	-	36,543	-	36,543
2,010	-	74,980	-	74,980
2,011	-	124,364	-	124,364
2,012	-	170,746	-	170,746
2,013	-	226,124	-	226,124
2,014	-	287,716	-	287,716
2,015	-	340,546	-	340,546
2,016	-	390,600	-	390,600
2,017	-	438,641	-	438,641
2,018	-	493,136	-	493,136
2,019	-	538,768	-	538,768
2,020	-	579,656	-	579,656



## CDM – Executive Board

**PROJECT DESIGN DOCUMENT FORM  
FOR AFFORESTATION AND REFORESTATION PROJECT ACTIVITIES (CDM-AR-PDD) - Version 05**

2,021	-	629,476	-	629,476
2,022	-	679,111	-	679,111
2,023	-	728,746	-	728,746
2,024	-	778,381	-	778,381
2,025	-	828,016	-	828,016
<b>Total</b> (tonnes of CO <sub>2</sub> e)				828,016

**A.10. Public funding of the proposed A/R CDM project activity:**

&gt;&gt;

There is no available public funding that will result in a diversion of Official Development Assistance (ODA) and financial obligations of any Parties under the UNFCCC. Thus, no ODA will be flowing into the project activities. Public funds from Government of India or the Government of the State of Himachal Pradesh are not available for this activity. The funds, which is a loan (Project ID/Loan Agreement – P093720), provided by the MHWDP (under a World Bank funded Watershed Development Project) partially support the restoration activities in degraded forests and community lands. However, such funding support is not available for A/R activities on private lands. As a consequence, households that own the private lands would need to bear the costs. The operating and maintenance costs of the project on degraded forestlands and community lands are not fully covered by the MHWDP, especially the costs that would be incurred after the closure of the project. The operational and maintenance costs on private lands would need to be borne by the households owning the lands. It is planned to cover the funding gap with the revenues from the sale of tCERs and sustainably harvested non-timber forest products under the project. Also, no ODA comes from parties included from Annex 1.

**SECTION B. Duration of the project activity / crediting period**

**B.1 Starting date of the proposed A/R CDM project activity and of the crediting period:**

&gt;&gt;

01/07/2006 (dd/mm/yyyy)

**B. 2. Expected operational lifetime of the proposed A/R CDM project activity:**

&gt;&gt;

60 years

**B.3 Choice of crediting period:**

**B.3.1. Length of the renewable crediting period (in years and months), if selected:**

&gt;&gt;

20 years, renewable twice



**B.3.2. Length of the fixed crediting period (in years and months), if selected:**

&gt;&gt;

NA

**SECTION C. Application of an approved baseline and monitoring methodology****C.1. Title and reference of the approved baseline and monitoring methodology applied to the proposed A/R CDM project activity:**

&gt;&gt;

The Consolidated afforestation and reforestation baseline and monitoring methodology “Afforestation and reforestation of degraded land” (AR-ACM0001/version 03)<sup>9</sup> is applied.

Tools:

- Combined tool to identify the baseline scenario and demonstrate additionality in A/R CDM project activities (version 01)
- Calculation of the number of sample plots for measurements within A/R CDM project Activities, Version 02
- Tool for testing significance of GHG emissions in A/R CDM project activities
- Estimation of emissions from clearing, burning and decay of existing vegetation due to implementation of a CDM A/R project activity tool
- Tool for estimation of GHG emissions related to displacement of grazing activities in an A/R CDM project activity (version 02)
- Tool for the identification of degraded or degrading lands for consideration in implementing CDM A/R project activities
- Procedure to define the eligibility of land for afforestation and reforestation project activities, Version01
- Procedure to determine when accounting of the soil organic carbon pool may be conservatively neglected in A/R CDM project activities;

**C.2. Assessment of the applicability of the selected approved methodology to the proposed A/R CDM project activity and justification of the choice of the methodology:**

&gt;&gt;

The proposed A/R CDM project activity complies with the conditions of the methodology AR-ACM0001, version 03. The project complies with the applicability conditions of the methodology in the following ways. The land eligibility is demonstrated using the A/R methodological “tool for the identification of degraded or degrading lands for consideration in implementing CDM A/R project activities<sup>10</sup>”. According to the procedure, a two-stage approach is suggested. Here stage 1 approach is adopted.

*Stage 1:* Documentary evidence is provided to prove that the land categories and the land parcels selected are degraded lands. In India, the Planning Commission and the National Remote Sensing Agency (NRSA

<sup>9</sup><http://cdm.unfccc.int/UserManagement/FileStorage/R91NFM6OXC4GJBW5PY0D8Q2HKLVASU>

<sup>10</sup>[http://cdm.unfccc.int/EB/Meetings/041/eb41\\_repan15.pdf](http://cdm.unfccc.int/EB/Meetings/041/eb41_repan15.pdf)



**PROJECT DESIGN DOCUMENT FORM  
FOR AFFORESTATION AND REFORESTATION PROJECT ACTIVITIES (CDM-AR-PDD) - Version 05**

describe degraded lands as ‘wastelands’. According to NRSA, which has made an estimate of the extent of wastelands (NRSA, 2005 and [http://dolr.nic.in/high\\_level.htm](http://dolr.nic.in/high_level.htm)), wastelands are defined as “degraded land which can be brought under vegetation cover with reasonable effort, and which is currently under-utilized and land which is deteriorating for lack of appropriate water and soil management or on account of natural causes”. NRSA has identified 28 categories of wastelands, which in fact cover all the lands which are not included under forestland definition and which are under crop production and infrastructure and settlements. According to the estimates made for Himachal Pradesh (Table C.2.1), out of 5.5 Mha of geographic area, croplands and forestland account for 1.9 Mha and wastelands account for 2.84 Mha and the rest is under infrastructure, settlements, etc. Thus, all the land categories and parcels considered for the proposed A/R CDM project do not meet the definition of forest and are not croplands and are categorized as wastelands according to NRSA. Wastelands account for 51.5% of the total geographic area of Himachal Pradesh state.

**Table C.2.1:** Area under different land categories

Category	Area (Mha)
Cropland	0.55
Forestland	1.44
Wasteland	2.84
Others	0.67
Total geographic area	5.50

- The A/R CDM project activity is implemented on degraded lands, which are expected to remain degraded or to continue to degrade in the absence of the project, and hence the land cannot be expected to revert to a non-degraded state without human intervention. The status of the three land categories is as follows.
  - *Degraded forestland:* These lands are devoid of any significant vegetation cover for the past several decades and are subjected to unsustainable biomass extraction (such as fuelwood and grass) over decades leading to loss of vegetation and continued degradation caused by soil erosion on the sloping topography (about 15-25 degrees).
  - *Degraded community land:* These lands have been continuously subjected to extensive grazing over decades, leading to loss of vegetation cover, suppression of regeneration and periodic fires. All such interventions have led to degradation of vegetation and soil erosion on the sloping topography (about 15-25 degrees).
  - *Degraded and abandoned private land:* These lands were once grasslands or forests on sloping hills, and were subjected to land conversion many decades ago (as per the information from PRA), for which no records exist. Cropping was practiced in the past. These lands were abandoned and left fallow due to low crop productivity caused by land degradation. These lands have very shallow soils subjected to continuous soil erosion and unsustainable grazing and harvesting of grass, further leading to degradation.

Further, most of the land considered for the project (about 87% of the total project area is under degraded forestland and degraded community land) is along the higher reaches of the hills. These sloping lands are subjected to soil erosion and have low soil organic carbon (SOC) as demonstrated by the SOC content per hectare compared to forests in the region (Refer to Table C.2.2). The soil organic carbon content of soils was estimated by sampling in the respective degraded land categories and estimating the SOC



**PROJECT DESIGN DOCUMENT FORM  
FOR AFFORESTATION AND REFORESTATION PROJECT ACTIVITIES (CDM-AR-PDD) - Version 05**

content in the laboratory through Walkley Black method (refer to Annex 3 on Baseline information for details of sampling)

- 26.98 tC/ha in degraded forestland
- 30.21 tC/ha in degraded community land
- 27.74 tC/ha in degraded and abandoned private land

Soil organic carbon density of forests in Himachal Pradesh based on 10 observations showed that the mean carbon stock is 123.79 tC/ha (ranging from 44 to 296 tC/ha; Table C.2.2). The mean carbon stock for pine and deodar, two important species of the region, is 70 and 165 tC/ha, respectively.

The soil organic carbon status of the three degraded land categories is less than one-fourth of the carbon stock in forests of the region. Thus it is possible to state that the land categories selected are in a highly degraded state.

**Table C.2.2:** Average above and belowground biomass (dry tonnes) and soil organic carbon under baseline condition in different land categories

Baseline stratum	Altitude	Aboveground biomass (t/ha)	Average aboveground biomass (t/ha)	Belowground biomass (t/ha)	Total biomass (above+belowground) (t/ha)	Soil organic carbon# (tC/ha)
Degraded forestland	High	1.80 (0.00-7.30) SE-0.79	1.55	0.43	2.24	26.98 (7.40-56.48) SE-1.51
	Medium	1.60 (0.01-3.95) SE-0.69		0.38	1.98	
	Low	1.24 (0.00-5.57) SE-0.52		0.30	1.54	
Degraded community land	High	2.73 (0.00-5.65) SE-1.15	1.49	0.65	3.38	30.21 (22.20-45.01) SE-3.01
	Medium	1.00 (0.00-4.05) SE-0.55		0.24	1.24	
	Low	0.75 (0.00-2.74) SE-0.51		0.18	0.93	
Degraded and abandoned private land	High	0.79 (0.00-2.96) SE-0.56	1.76	0.19	0.98	27.74 (13.39-49.88) SE-1.14
	Medium	1.59 (0.00-3.61) SE-0.38		0.38	1.97	
	Low	2.89 (0.00-3.94) SE-0.69		0.69	3.59	
<b>Soil carbon stocks in non-degraded soils of Himachal Pradesh</b>						
Deodar (2 studies)						164.74 (286.85-42.62)



**PROJECT DESIGN DOCUMENT FORM  
FOR AFFORESTATION AND REFORESTATION PROJECT ACTIVITIES (CDM-AR-PDD) - Version 05**

Pine (8 studies)		69.46 (104.83-37.63)
Forests (10 studies)		123.79 (295.68-44.16)

*#Figures in parenthesis indicate soil organic carbon range  
SE is standard error*

- Encroachment of natural tree vegetation that leads to the establishment of forests according to the host country definition of forest for CDM purposes is not expected to occur.
  - All the three land categories considered for the CDM A/R project have remained degraded and are continuing to degrade as evident from the remote sensing maps. Remote sensing maps of tree crown over a period of 16 years (1989 to 2005) showed no significant change in the tree crown cover by remaining under 10% tree crown suggesting absence of natural regeneration.
  - The land is not suitable for natural regeneration as different species require certain specific conditions for regeneration which do not exist in the land parcels selected
  - Absence of seed sources
  - Non-suitability of land conditions for successful establishment of seedlings
- Flooding irrigation is not part of the project activity
  - The land categories are characterised by 15 to 25 degree slope, thus unsuitable for irrigation. Furthermore, there are no water sources in the hills as all water is accumulated and stored in the valley region.
  - According to the silvicultural practices adopted by the Forest Department in the mid-Himalayan regions, irrigation is never provided and further there is no source of water in the sloping hills (Working Plans of Forests and Silvicultural Manual of Government of Himachal Pradesh)
- If project activities are implemented on organic soils, drainage is not allowed and not more than 10% of the project area may be disturbed as result of soil preparation for planting
  - Observation of physical features of land indicates the absence of the problem of drainage
  - The project area is characterised by steep slopes, absence of water logging and further irrigation practice is not adopted, thus drainage issue is not relevant
  - Further, organic soils are absent in most of the districts of Himachal Pradesh.
- The establishment of project shall not decrease availability of fuelwood
  - All the three land categories considered for the CDM A/R project have remained degraded and are continuing to degrade as evident from the remote sensing maps.
  - The current vegetation status is very poor with 1.92 t (degraded forestland), 1.85 t (degraded community land) and 2.18 t/ha (degraded and abandoned private land) of biomass (total above and belowground biomass) per hectare. Thus, at such extremely low growing stock values, the MAI and the biomass production available as fuelwood is likely to be insignificant.

The biomass available for use as fuelwood in the baseline is insignificant and further on implementation of A/R CDM project, households will be permitted to gather fuelwood from the area brought under project activities from the existing shrubs and trees. Further, the fallen woody twigs and branches from the trees planted under the A/R CDM project will also be available to the households as fuelwood, thereby the total quantity of fuelwood available from the project area is estimated to be higher than under the baseline or pre-project situation.

Decision 11/CP.7 requires parties to account for carbon stock changes in five pools: aboveground



**PROJECT DESIGN DOCUMENT FORM  
FOR AFFORESTATION AND REFORESTATION PROJECT ACTIVITIES (CDM-AR-PDD) - Version 05**

biomass, belowground biomass, dead wood, litter and soil organic carbon<sup>11</sup>. This was reiterated in decision 19/CP.9<sup>12</sup>. The definitions for the five pools are given in the Good Practice Guidance for LULUCF<sup>13</sup>. The carbon pools selected for the project according to the AR-ACM0001/Version 03 methodology are given in Box C.3.1.

**Box C.2.3: Carbon pools selected for project monitoring**

Carbon Pools	Selected (answer with yes or no)	Justification / Explanation
Above ground	Yes	Major carbon pool subjected to the project activity
Below ground	Yes	Major carbon pool subjected to the project activity
Dead wood	No	As there are only a few pre-project living trees and the lands to be planted are degraded, degrading or in a low-level steady state, carbon stocks in dead wood in the baseline scenario can be expected to decrease more or increase less, relative to the project scenario. Therefore, this pool can be conservatively omitted as per the provisions of the methodology.
Litter	No	As the land to be planted are degraded and degrading or in a low-level steady state, carbon stocks in litter in the baseline scenario can be expected to decrease more or increase less, relative to the project scenario. Therefore, this pool can be conservatively omitted as per the provisions of the methodology.
Soil organic carbon	Yes	The land selected for the A/R CDM project has been subjected to erosion and degradation over decades, leading to low soil organic matter status. The proposed reforestation activity is projected to increase the soil organic carbon status and default method is adopted for accounting the soil organic carbon pool.

Aboveground biomass, belowground biomass and soil organic carbon are the three carbon pools selected for monitoring and reporting in the project. Carbon stocks in the pools dead wood and litter will not decrease more as a result of the proposed A/R CDM project activity than in the baseline, because the A/R activities will be implemented on degraded undemarcated forestland, degraded community land and degraded and abandoned private land. In other words, the carbon stocks in these pools are expected to increase relative to the baseline scenario, which otherwise would have degraded further or remained in a low steady state. However, this increase will be marginal during the initial years and communities will collect all the litter available in the form of fallen dry twigs for use as fuelwood during the subsequent years. In the case of dead wood, the likelihood of occurrence is very less in a growing forest for it takes 100-120 years for forests in Himachal Pradesh to reach maturity and for trees to senesce and die. Therefore, to be conservative, it is chosen to account only for aboveground biomass, belowground biomass and soil organic carbon pools in the proposed A/R CDM project activity.

<sup>11</sup> FCCC/CP/2001/13/Add.1, 54~63. <http://unfccc.int/resource/docs/cop7/13a01.pdf>

<sup>12</sup> FCCC/CP/2003/6/Add.2, 13~31, <http://unfccc.int/resource/docs/cop9/06a02.pdf>

<sup>13</sup> FCCC/CP/2003/6/Add.2, 13~31, <http://unfccc.int/resource/docs/cop9/06a02.pdf>



**PROJECT DESIGN DOCUMENT FORM  
FOR AFFORESTATION AND REFORESTATION PROJECT ACTIVITIES (CDM-AR-PDD) - Version 05**

The greenhouse gases (GHG) that are expected to emit during the implementation of the proposed A/R CDM project activity are CO<sub>2</sub>, and CH<sub>4</sub>. They are expected to result from:

- Burning of woody biomass

Source	Gas	Included/ excluded	Justification / Explanation
Burning of woody biomass (excluding herbaceous biomass)	CO <sub>2</sub>	Excluded	Carbon stock decreases due to burning are accounted as a carbon stock change
	CH <sub>4</sub>	Included	Non-CO <sub>2</sub> gas emitted from woody biomass burning
	N <sub>2</sub> O	Excluded	Potential emissions are negligibly small

**C.3. Description of strata identified using the *ex ante* stratification:**

>>

The *ex-ante* stratification procedures outlined in Section II.3 of the approved methodology have been followed as described below:

The critical factors that will determine the stratification and the carbon stocks include the altitude, slope, soil depth and pre-existing vegetation conditions. The following stratification procedure is adopted for the project.

***Baseline scenario of degraded forest and community lands***

These two land categories are owned by Government agencies and have similar tenurial condition. The only plausible alternative for the degraded forest and community land is continued degradation of the land categories.

- i. The national and state policies ban conversion of degraded forest and community land for non-forestry purposes, particularly to cropland
- ii. Forestlands are demonstrated to be getting degraded since the area under open forests (10-40% tree crown) is increasing (81.6% during the period 1997 to 2003)
- iii. The current vegetation status is very poor with 1.55 t (degraded forestland) and 1.49 t (degraded community land) of biomass (total above and belowground biomass) per hectare (Table C.2.2)
- iv. Soil organic carbon status of the soil is very low (around 28 tC/ha, refer to Table C.2.2)
- v. Sloping hilly terrain of the bare land or poor vegetation cover leads to increased soil erosion and degradation and decrease in carbon stocks
- vi. Absence of root stock and natural seed sources in the land categories selected for A/R project.
- vii. The data indicates that forest and community lands have not been converted to cropland and the abandoned private lands have remained in that state for long periods
- viii. Remote sensing analysis for the period 1989 and 2005 shows that the land parcels considered have remained under <10% tree crown.

***Baseline scenario of degraded private lands***

In the case of degraded and abandoned private land, the only plausible option is to remain as abandoned and fallow, and subjected to further degradation or reforestation of these lands under CDM.

- These lands have been left abandoned for over 20 years



**PROJECT DESIGN DOCUMENT FORM  
FOR AFFORESTATION AND REFORESTATION PROJECT ACTIVITIES (CDM-AR-PDD) - Version 05**

- These lands are on the hilly slopes, degraded and are not suitable for profitable cropping (Refer to Section C.6)
- Area under agriculture has declined in the Himachal Pradesh state over the last two decades, indicating no new area is brought under crops
- The biomass stock on degraded private lands is low at 1.76 t/ha (Table C.2.2)
- The soil organic carbon on the degraded and abandoned private lands is low at 27.74 tC/ha (Table C.2.2).

<i>Baseline stratum</i>	<i>Land use category</i>	<i>Description</i>	<i>Status</i>
Baseline stratum 1	Degraded forestland	<ul style="list-style-type: none"> <li>- Current vegetation status poor</li> <li>- Low biomass of 1.55 t/ha</li> <li>- Low soil organic carbon of 26.98 tC/ha</li> <li>- Absence of root stock and natural seed sources</li> <li>- no vegetation regeneration has occurred</li> <li>- &lt;10% tree crown as indicated by remote sensing maps</li> </ul>	Continuation of existing land use under the baseline
Baseline stratum 2	Degraded community land	<ul style="list-style-type: none"> <li>- Current vegetation status poor</li> <li>- Low biomass of 1.49 t/ha</li> <li>- Low soil organic carbon of 30.21 tC/ha</li> <li>- &lt;10% tree crown as indicated by remote sensing maps</li> <li>- no vegetation regeneration has occurred</li> </ul>	Continuation of existing land use under the baseline
Baseline stratum 3	Degraded private land	<ul style="list-style-type: none"> <li>- Land abandoned for over 20 years</li> <li>- Low biomass stock of 1.76 t/ha</li> <li>- Soil organic carbon low at 27.74 tC/ha</li> <li>- No vegetation regeneration has occurred</li> </ul>	Continuation of existing land use under the baseline

The factors that determine the land use/land cover change over time are state and national policies which influence land use change, status of the land, in particular vegetation, and rate of A/R under various programmes. The historical land use and local and sectoral policies and regulation and their likely implications for the A/R CDM project area are analysed using the following sources of data.

- *Data source 1:* Remote sensing maps with tree crown cover (<10%, 10-40%, etc) were obtained from the Forest Survey of India for the years 1989 and 2005 to demonstrate that the land considered for A/R CDM are not forests and have remained degraded over the period under consideration (at least since 1989).
- *Data source 2:* Data and information on national and state policies on land use and A/R activities implemented on degraded lands in the past and lands proposed for A/R activities in the future in the absence of the proposed CDM A/R project was obtained from the State Forest Department.

**PROJECT DESIGN DOCUMENT FORM  
FOR AFFORESTATION AND REFORESTATION PROJECT ACTIVITIES (CDM-AR-PDD) - Version 05**

- Further, information from the Forest Department in order to demonstrate that the lands proposed would continue to be in the existing land use reflecting the continuation of the baseline.
- *Data source 3:* Data from Forest Survey of India on the extent of land under different tree crown density classes at the state and district level was obtained for different periods to demonstrate that the forests are subjected to degradation. The increase in area under open forests and reduction in area under dense forest in the districts covered under the project highlights the continuing degraded status of carbon stocks *Data source 4:* Data on area brought under A/R over the years was obtained from State Forest Department to demonstrate that the rate of A/R activity is declining in the recent years *Data source 5:* Wasteland statistics from the National Remote Sensing Agency was obtained to demonstrate that a large extent of wasteland is available in the state for A/R activities
  - *Data source 6:* Data from *vegetation* surveys conducted in sample land categories was used to demonstrate the low biomass status, indicating the degraded status of lands and continued degradation of land (Table C.2.2)
  - *Data source 7:* Data from soil sampling and laboratory analysis showed low soil organic carbon reflecting the continuation of land degradation in the baseline scenario (Table C.2.2)

To summarize:

***Aboveground and below-ground tree biomass***

- o The total biomass, above and belowground (in tonnes of dry matter) is low under the baseline scenario, (Refer to Table C.2.2)
  - Degraded forestland: 1.55 t/ha
  - Degraded community land: 1.49 t/ha
  - Degraded and abandoned private land: 1.76 t/ha

Since the aboveground biomass growing stock in the baseline is low, the accumulation of dead wood or litter is likely to be insignificant or absent. If 5% of the aboveground biomass is assumed as litter and deadwood, the annual accumulation rate will be highly insignificant.

***Aboveground non-tree biomass***

The assessment of non-tree aboveground biomass indicates that the grass productivity of degraded forest and community land categories is very low and ranges from 1.7 to 1.3 dry tonnes/ha/year, (Table C.4.1). Refer to Annex 3 on baseline information for details of field studies for estimating grass productivity. Even in degraded private land where there is comparatively less anthropogenic pressure, the grass productivity recorded is only 2 dry tonnes/ha/year.

**Table C.4.1:** Grass (herb layer) productivity (in dry tonnes/ha/yr) in different land categories under baseline condition, estimated by conducting field measurements of green biomass, which is converted to dry biomass

<b>Baseline stratum</b>	<b>Grass production (dry t/ha/yr)</b>
Degraded forestland	1.7 (2.5)
Degraded community land	1.3 (2.0)
Degraded and abandoned private land	2.0 (3.0)

*Figures in parenthesis is maximum grass biomass recorded during baseline during field studies*

***Step 1: Stratification according to pre-existing conditions***





**PROJECT DESIGN DOCUMENT FORM  
FOR AFFORESTATION AND REFORESTATION PROJECT ACTIVITIES (CDM-AR-PDD) - Version 05**

Survey of the records of the project area as well as field visits and observations revealed the following factors as critical in influencing the aboveground biomass, below-ground biomass and soil carbon pools.

Current land use, tenure and the location of the land categories included in the project with respect to the habitation are discussed below. The location of the three land categories with respect to habitation is likely to characterize carbon stocks:

- *Degraded forestland*: These lands are located at higher elevation in all the GPs where the grazing pressure is relatively less and these lands are farthest from habitation. This land category is largely without tree cover and is under the control of the state Forest Department.
- *Degraded community land*: These lands are under the control of the revenue department on which communities have rights of access to grazing and fuelwood collection. These lands are closer to habitation compared to degraded forestlands. As a consequence, these lands are subjected to intensive pressures of grazing and fuelwood collection.
- *Degraded and abandoned private land*: These lands are at lower elevation close to the valley and are close to human habitation. These lands were cultivated on slopes and partially terraced conditions in the past. The lands are abandoned for more than 10 years and are currently used for fodder collection and livestock grazing.

The above three land categories form the primary basis for stratification under the baseline scenario taking into account the factors of pre-existing vegetation, tenure, slope and biotic pressure.

***Step 2: Stratification according to planned A/R CDM project activity***

It is proposed to adopt the following stand models suitable to the three broad land categories and altitudinal sub-strata for each land category (Refer to Section A.5.3). The selected parcels for A/R activity would belong to one of the three sub-strata. It is likely that a given gram panchayat, no matter belonging to which division or district, can have all the three altitudinal sub-strata or two or only one of the sub-strata. Further, each of the reforestation models could belong to or occur at any of the three altitudinal strata. The three altitude based sub-strata are as follows:

- High – 1400 to 1800 m
- Medium – 1100 to 1400 m
- Low – 600 to 1100 m

Each of the three broad land categories are further stratified based on the altitudinal range due to the following rationale.

- The soil status is likely to vary across high, medium and low altitudes
- The species suitability varies with altitude
- The growth rate of biomass could vary with altitude
- The settlements are usually in the lower altitudinal strata.

Under the A/R project, the first stage stratification is restricted to the three reforestation stand models, relevant to respective land categories for the following reasons.

- The species mix for each of the above models was evolved based on land suitability analysis and consultation process involving multiple stakeholders.
- The planting will be done in a phased manner over a period of six years where all the three reforestation models will be implemented in a systematic manner. The table below provides an indication of the area of plantation under the three reforestation models.



**PROJECT DESIGN DOCUMENT FORM  
FOR AFFORESTATION AND REFORESTATION PROJECT ACTIVITIES (CDM-AR-PDD) - Version 05**

Year	FOREST				COMMUNITY				PRIVATE			
	Low	Medium	High	Total	Low	Medium	High	Total	Low	Medium	High	Total
2006-07	16	66	65	146	0	5	14	18	0	0	0	0
2007-08	20	67	8	95	81	6	16	103	5	0	0	5
2008-09	150	154	184	488	19	0	0	19	0	0	0	0
2009-10	368	396	347	1111	5	7	0	12	0	0	0	0
2010-11	231	191	419	840	5	9	47	62	218	193	58	469
2011-12	193	95	208	496	15	40	24	79	9	28	22	59
<b>Total</b>	<b>976</b>	<b>970</b>	<b>1231</b>	<b>3177</b>	<b>125</b>	<b>67</b>	<b>101</b>	<b>293</b>	<b>232</b>	<b>221</b>	<b>80</b>	<b>533</b>

- Further, there is no difference in the silvicultural practices for different parcels of land belonging to the different GPs, for a given stand model.
- The location of the three land categories described earlier, with respect to elevation and proximity to human habitation is nearly identical in all GPs, such as degraded forestland at a higher elevation farthest from habitation in all the GPs. This does not vary across watershed divisions and GPs.
- The soil carbon density across different sample plots in different GPs for a given land category is low and is in the range (7.40 to 56.48 tC/ha, for degraded forestland with a standard error of 1.51, 22.20 to 45.01 tC/ha, for degraded community land with a standard error of 3.01 and 13.39 to 49.88 tC/ha, for degraded private land with standard error of 1.14, refer to Table C.2.2).
- Carbon stock changes will be determined by species choice, their growth rates, survival and density of stocking and, apart from site class and topography.

### ***Step 3: Final ex-ante stratification***

The stratification adopted for the pre-existing vegetation under the baseline conditions is geographically delineated according to the three broad land categories as described earlier. The three reforestation models were further stratified based on the altitude of the parcels selected for reforestation. The following three-stage final *ex-ante* stratification is adopted based on a combination of pre-existing conditions, reforestation model and altitudinal sub-strata (Figure C.4.1).

*Stage 1:* Pre-existing land categories namely; degraded forestland, degraded community land and degraded and abandoned private land

*Stage 2:* Reforestation models namely;

- restoration forestry on degraded forestland
- community forestry on degraded community land and
- farm forestry on degraded and abandoned private land

*Stage 3:* The final *ex-ante* A/R stratification consists of three altitudinal reforestation models under each of the reforestation models

- ***Restoration forestry***; high, medium and low strata
- ***Community forestry***; high, medium and low strata
- ***Farm forestry***; high, medium and low strata

**PROJECT DESIGN DOCUMENT FORM  
FOR AFFORESTATION AND REFORESTATION PROJECT ACTIVITIES (CDM-AR-PDD) - Version 05**

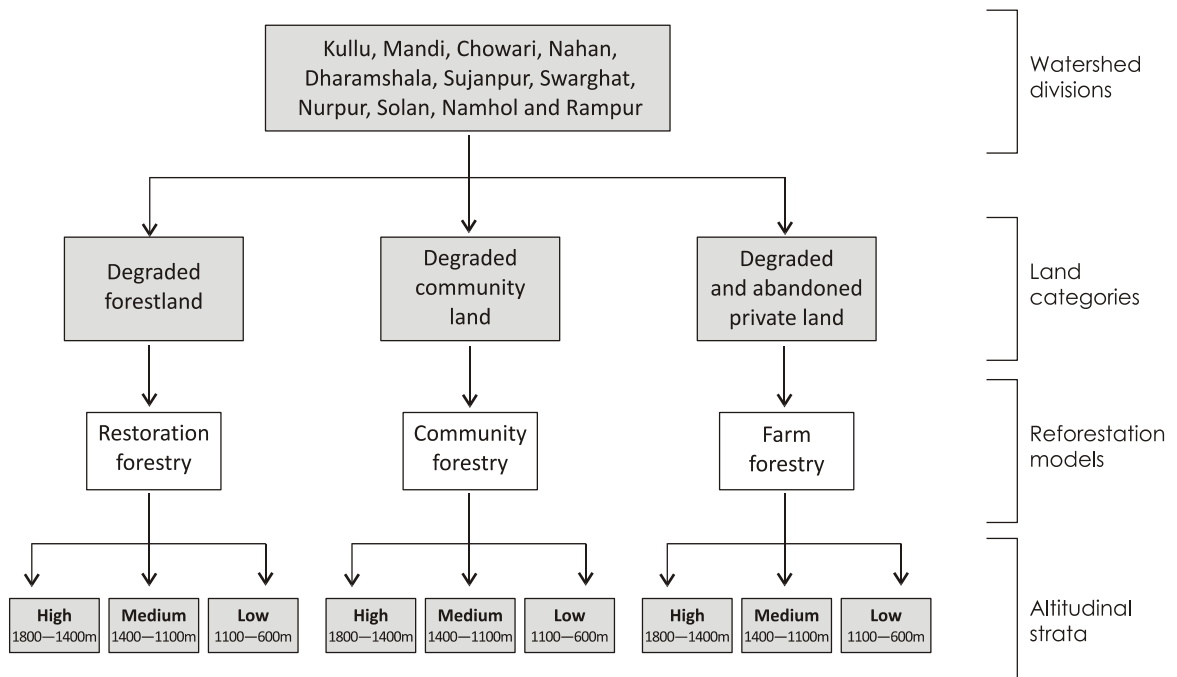

**Figure C.4.1:** Final *ex-ante* stratification of proposed reforestation activity

**C.4. Identification of the baseline scenario (if the “Combined Tool to identify the baseline scenario and demonstrate additionality in A/R CDM project activities” is applied proceed to paragraph C.6):**

>>

See paragraph C.6 below

**C.4.1. Description of the application of the approach to identify the most plausible baseline scenario (separately for each stratum):**

>>

**C.4.2. Description of the identified baseline scenario (separately for each stratum):**

>>

**C.5. Assessment and demonstration of additionality (if the “Combined tool to identify the baseline scenario and demonstrate additionality in A/R CDM project activities” is not used):**

>>

See paragraph C.6 below

**C.6. Identification of the baseline scenario and demonstration of additionality using the “Combined tool to identify the baseline scenario and demonstrate additionality in A/R CDM project activities” (if required by the selected approved methodology):**

>>



**PROJECT DESIGN DOCUMENT FORM  
FOR AFFORESTATION AND REFORESTATION PROJECT ACTIVITIES (CDM-AR-PDD) - Version 05**

In this section, additionality of the proposed A/R CDM project is demonstrated using the step-wise approach outlined in the “*Combined tool to identify the baseline scenario and demonstrate additionality in A/R CDM project activities*”<sup>14</sup>.

**Step 0: Preliminary screening based on the starting date of the A/R project activity**

The starting date for the project is 1 July 2006. The need for the proposed CDM project activity is highlighted in the project implementation document of the Mid Himalayan Watershed Development Project (Project implementation Plan-HPMHWDP, 2006). The Importance of reforestation activities to enhance incomes and improve rural livelihoods by way of selling CERs was considered and documented in ‘Environment and Social Assessment Report of the Mid-Himalayan Watershed Development Project’ of HPMHWDP (2006). According to the project document, consideration of the CER revenue facilitates the implementation of the watershed development project.

The starting date is defined on the basis of the plantation plan for the project. The draft report on Environmental and Social Assessment (ESA) for this project was published for public review through World Bank’s Info Shop on 20 September 2005 (No. 1 below). The ESA report, page 23-25, introduces the concept of CDM, its benefits to the project and communities and also lists risk mitigation measures. The need for the proposed CDM project activity is highlighted in the project implementation document of the Project (No. 2 below). These two documents are then also referred to in the Project Appraisal Document (PAD) in Annex 13 on page 54 (No.3 below).

As a published document, the ESA report confirms the awareness of CDM prior to the project activity start date and the role of CDM in proceeding with the community level plantation. In line with the findings and recommendations in the two reports mentioned above, the Project Idea Note (PIN) provided details of the mechanism for fund flow to the beneficiary communities, listed villages (Gram Panchayats) interested in joining the CDM project and listed the preferred species selected by the communities for plantation under this project.

**Chronology of Events for the CDM Bio Carbon Project**

Sr. No.	Activity	Time Period
1	Draft report on Environment and Social Assessment for the project published in the World Bank Info Shop (E1224) (Web-link: <a href="http://go.worldbank.org/NXEE1A1ZT0">http://go.worldbank.org/NXEE1A1ZT0</a> )	20 September, 2005
2	The concept of reforestation to enhance Watershed/ Catchment treatment using CDM revenue included in the draft Project Implementation Plan (Para 1.6.7) of the project	September 2005
3	Project Appraisal Document (PAD) approved (PAD refers to the documents above in Annex-13 on page-54)	14 November 2005
4	Informal communication between the project team and the World Bank regarding inclusion of the project in BioCF and preparation of a PIN	2005-2006
5	Annual Plan of operation of plantations under HP reforestation (Bio Carbon) Project	April 2006

<sup>14</sup>[http://cdm.unfccc.int/EB/Meetings/035/eb35\\_repan19.pdf](http://cdm.unfccc.int/EB/Meetings/035/eb35_repan19.pdf)



## CDM – Executive Board

**PROJECT DESIGN DOCUMENT FORM  
FOR AFFORESTATION AND REFORESTATION PROJECT ACTIVITIES (CDM-AR-PDD) - Version 05**

6	Project Start date (based on plantation data)	1 July 2006
7	Final Project Idea Note submitted to BioCF	20 September 2006
8	Project accepted in BioCF portfolio	November 2006
9	Letter of Intent to work on a CDM Bio Carbon Project signed between Govt. of HP and World Bank	January, 2007
10	Carbon Finance Document of Himachal Pradesh Bio Carbon Project approved by BioCF	April 2007
11	Methodology AR-ACM0001 version 1 was approved (EB38, Annex 7)	14 March 2008
12	Council of Ministers of Govt. of HP approves Project Design Document (PDD) of CDM Bio Carbon Project	July 2008
13	Project submitted for Global Stakeholder Process on UNFCCC CDM website	7 April 2009
14	Letter from Additional Chief Secretary (Forest) regarding non-availability of government funds	16 April 2009
15	Validation site-visit	8-18 April 2009
16	CDM Authority of Govt. of India gives Host Country Approval	July 2009
17	Government of Spain gives Letter of Approval	December 2009

**Step 1: Identification of alternative scenarios**

Alternatives to the A/R project activities consistent with existing laws and regulations are identified using the steps provided in the Combined Tool<sup>15</sup>.

**Sub-step 1a:** The alternative uses of the public lands (degraded forest and community lands) and the private lands (degraded and abandoned private lands) outlined below.

Public land (degraded forest and community land)

- Continuation of existing land use or *status quo*
- Proposed project not undertaken as an A/R CDM project

*Degraded forestland:* The State Forest Department has control over the degraded forestland. Currently, this land category is subjected to degradation due to unsustainable grazing. Another alternative is to implement the A/R activity not as a CDM project.

*Degraded community land:* The Revenue Department has control over community land. It is subjected to degradation due to unsustainable grazing. The panchayats or village communities cannot unilaterally take decisions on the utilization of this land. It is transferred to the Forest Departments for undertaking A/R activities. In such cases, village panchayats are involved in planning and implementing the plantation schemes. An alternative is to implement the A/R activity not as a CDM project.

Alternative uses of private land (degraded and abandoned private land) include

- Continuation of existing land use or *status quo*
- Proposed project not undertaken as an A/R CDM project.

<sup>15</sup> [http://cdm.unfccc.int/EB/Meetings/035/eb35\\_repan19.pdf](http://cdm.unfccc.int/EB/Meetings/035/eb35_repan19.pdf)



**PROJECT DESIGN DOCUMENT FORM  
FOR AFFORESTATION AND REFORESTATION PROJECT ACTIVITIES (CDM-AR-PDD) - Version 05**

*Private lands (degraded and abandoned private lands)* are controlled by the individual farmers. These lands are currently used for collection of grass and for grazing livestock, which is likely to continue in the future. These private abandoned lands are closest to the village settlement and are therefore the first preferred choice for grazing due to their proximity unlike forest lands which are away from settlements and are along the higher reaches of the hills. However, considering the limited alternative use of such grasslands for households, they would continue to be used for grass collection and grazing and would be in status quo. An alternative is to implement the A/R activity not as a CDM project.

**Sub-step 1b.** *Consistency of credible alternative land use scenarios with enforced mandatory applicable laws and regulations:* The mandatory laws and regulations and forest policies do not permit the use of public lands for agriculture. The private lands, although could be used for agriculture or horticulture, considering these lands have remained abandoned for more than a decade, it is unlikely that they will be used for agriculture. The implementation of A/R activity is not a mandatory requirement, the public and private lands would continue to be in the degraded state.

## **Step 2: Barrier analysis**

The barrier analysis is used to demonstrate that the alternative use of public and private lands for A/R activity faces investment, technological and ecological barriers.

**Sub-step 2a:** *Identification of barriers that would prevent the implementation of at least one alternative land use scenarios:*

The barriers to implementation of the project activities are presented in Table C.6.1. Furthermore, how these barriers do not prevent the implementation of at least one of the alternatives is also presented in Table C.6.3.

### **a) Investment barriers**

- *Lack of investment from the state government for public land (Degraded forestland and community land):* The governments budgetary allocation for forest sector is for protection and regeneration of the three categories namely, i. reserve forests, ii) protected forests and iii) undemarcated forests. The government's priority in the forest sector is primarily the reserve and protected forests. The current budget available from the Government of India and the state government is/will not be adequate even for treating the degraded patches within the priority areas of reserve and protected forests. Therefore the undemarcated forests are beyond the purview of any investment available at present – which are primarily the parcels considered for the project. A letter from the senior most Secretary in the government clearly states the absence of investment for A/R activities in the identified land categories of degraded forestland, community land and private land. The land parcels of these land categories identified for the A/R CDM project have remained in the degraded state (<10% tree crown) since 1990 atleast (as evidenced from remote sensing maps). Further, an assessment of the investment on the area brought under A/R have indicates that the area brought under A/R has declined from 1,63,826 ha in the seventh five year plan period of 1985 to 1990 to 86,341 ha in the tenth five year plan period of 2002-2007. The decline in investment is further compounded by increase in the wage rates, leading to net decrease in investment at the state level as well as per hectare. This clearly demonstrates that investment for A/R is a barrier.

**PROJECT DESIGN DOCUMENT FORM  
FOR AFFORESTATION AND REFORESTATION PROJECT ACTIVITIES (CDM-AR-PDD) - Version 05**

- *Lack of investment from the state government for private land (Degraded and abandoned private land)*  
Under the current norms, no dedicated state budgetary allocation is available for afforestation on private lands in the state.
- *Access to international capital markets* is lacking for the proposed A/R CDM project activity on all three categories of land as returns are low and involve long gestation periods. Further, there is no provision or experience of private sector investment for forestry activities on public lands for commercial purposes.

**Status quo:** No investment is required for maintaining the *Status quo*. No financial or technological or policy intervention is required to maintain the *Status quo*. Thus, *Status quo* is the most likely plausible alternative with no barriers.

**b) Technological barriers**

There are several technological barriers such as lack of access to quality planting material and lack of infrastructure for implementing reforestation practices as evidenced by the higher investment cost for nursery and other activities. Significant investment in training, skill development and improved silvicultural practices is required, which would not be available for A/R activity if undertaken as a non-CDM project. Farmers do not have the skill and knowledge required for undertaking A/R activities on degraded and abandoned private land.

**Status quo:** The technological barriers will not prevent the *Status quo* as no technological interventions are required to continue with the existing land use.

**c) Ecological barriers**

It was demonstrated in Section C.5.1 that the land categories and the parcels selected for A/R CDM are in a degraded state and are continuing to degrade. The topography of the land categories is undulating. Further these lands are subjected to erosion over the years and are currently characterised by shallow soils. The soil organic carbon, an indicator of soil fertility is also very low (Table C.2.2) in the range of 26.98 to 30.21tC/ha. Thus the ecological status of these land categories and parcels selected for A/R is a barrier under normal A/R undertaken by the state forest department. These lands require additional soil, water and land management practices, requiring additional investment and skills. Besides, because of harsh and hostile ecological conditions, establishment period for seedlings/plantations is extended to 15-20 years. With CDM money available, the financial resources for maintenance and after-care of plantations become available for the extended period.

**Status quo:** The ecological barriers will not prevent the land remaining in the same status.

An analysis of the barriers and how CDM project implementation helps overcome these barriers is presented in Table C.6.1.

**Table C.6.1: Barrier analysis**

Barrier that would prevent the implementation of the type of	Sub-step 3a. How it prevents the implementation of this type of proposed	Sub-step 3b. How it does not prevent the implementation of the alternative.	Source of transparent and documented evidence.	How CDM project implementation enables overcoming the barrier.
--	--	---	--	--



## CDM – Executive Board

**PROJECT DESIGN DOCUMENT FORM  
FOR AFFORESTATION AND REFORESTATION PROJECT ACTIVITIES (CDM-AR-PDD) - Version 05**

proposed project activity from being carried out if the project activity was not registered as an A/R CDM activity.	project activity. How it would prevent potential project proponents from carrying out the proposed project activity if it was not expected to be registered as an A/R CDM project activity.			
Investment barrier	The current budget available from the Government of India and the state government is/will not be adequate even for treating the degraded patches within the priority areas of reserve and protected forests. Therefore the undemarcated forests are beyond the purview of any investment available at present – which are primarily the parcels under the project.	No investment, financial or technological or policy intervention is required to maintain the <i>Status quo</i> .	Letter from Secretary, Govt. of HP	CDM revenue will provide for investment on undemarcated forestlands that are currently not under the purview of the government.
Barrier due to technology:	The topography of the land categories is undulating. Further these lands are subjected to erosion over the years and are currently characterised by shallow soils. Significant technological interventions are needed, requiring additional investment.	The technological barriers will not prevent the land remaining in the same status, since no technological intervention is required	Baseline information generated through field studies, presented in Table C.2.2	These lands require additional soil, water and land management practices, requiring additional investment and skills that will come from CDM revenue
Barrier due to local ecological conditions: Degraded soil (e.g. water/wind erosion, salination, etc.)	The project land parcels are part of mid-himalayan altitude (range on 600 to 1600 m) with most land having a	Not a barrier since no land preparation or silvicultural practices or planting is required	Working Plan of Forest Department and Compartment History files	CDM revenue will facilitate investment to implement soil quality improvement practices and improved tending,





**PROJECT DESIGN DOCUMENT FORM  
FOR AFFORESTATION AND REFORESTATION PROJECT ACTIVITIES (CDM-AR-PDD) - Version 05**

	slope of 15-25 degrees. This requires higher investment for land preparation and other silvicultural practices. Land is highly degraded and cannot support any activity other than A/R			management and maintenance.
--	--	--	--	-----------------------------

***Sub-step 2b: Elimination of land use scenarios that are prevented by the identified barriers***

The alternative land use scenario “proposed project not undertaken as an A/R CDM project” identified in *sub-step 1a* above can be eliminated from land use scenarios due to the barriers it faces. The three baseline strata have poor vegetation and soil carbon status and are in a degraded state. They are likely to get degraded further due to soil erosion and other biotic pressures. The analysis presented in Table C.6.2 shows that continuation of the existing land use or *status quo* is not prevented by the ecological, technical, financial, institutional, social, and cultural barriers as the three land categories selected have been in degraded state for several decades (Refer to Section C.5.1).

***Sub-step 2c. Determination of baseline scenario (if allowed by the barrier analysis)***

The plausible alternative scenarios, their feasibility and justification are provided in Table C.6.2. Step-wise description of the selection of baseline scenario is provided in Section C.5.2.

**Table C.6.2:** Current land use, alternative land use and feasibility

Current land use	Alternative land use	Feasibility of the alternative	Justification
Degraded forestland	1. Continuation of the existing land use or <i>status quo</i>	Yes	Has remained in this state for several decades and has not been brought under any plantation forestry schemes, possibly due to barriers. <i>Status quo</i> doesn't require any investment or any intervention and face no barriers
	2. Reforestation activity	No	Due to the barrier of non-availability of funds, these lands are unlikely to be brought under plantation forestry. At current rates of A/R it will take >200 years to afforest all the potential degraded lands in Himachal Pradesh
Degraded community land	1. Continuation of the existing land use or <i>status quo</i>	Yes	Has remained in this state for several decades and has not been brought under any plantation forestry scheme, due to financial barriers. <i>Status quo</i> doesn't require any investment or any intervention and face no barriers



**PROJECT DESIGN DOCUMENT FORM  
FOR AFFORESTATION AND REFORESTATION PROJECT ACTIVITIES (CDM-AR-PDD) - Version 05**

	2. Reforestation activity	No	Due to the barrier of non-availability of funds, these lands are unlikely to be brought under plantation forestry. At current rates of A/R it will take >200 years to afforest all the potential degraded land in Himachal Pradesh
Degraded and abandoned private land	1. Continuation of the existing land use or <i>status quo</i>	Yes	These lands have remained in this state for several decades and have not been brought under any plantation forestry scheme or agriculture or horticulture, due to financial and other barriers such as non-suitability of hilly slopes for commercial cropping. Further, poor grass production on these lands makes them unsuitable for profitable grass production. Therefore maintenance of <i>status quo</i> is the only feasible option given these private lands are traditionally used for livestock grazing, as they are closest to the village settlements, located on the lower reaches of the hills making them the preferred location for livestock grazing as compared to forest and other lands that are on the higher reaches of the hills. Maintenance of <i>status quo</i> thus faces no barriers and no investment and intervention is required
	2. Reforestation activity	No	Due to the barrier of non-availability of funds, these lands are unlikely to be brought under plantation forestry.

Is reforestation activity not undertaken as an A/R CDM project included in the list of land use scenarios that are not prevented by any barrier?

→ no, then:

Does the list contain only one land use scenario?

→yes, the remaining land use is the baseline scenario, which is *status quo* in this case.

**Step 4: Common practice analysis**

Himachal Pradesh has been implementing afforestation programme since early 1980s, when social forestry programme was launched in India. The area afforested in the initial years ranged from 20,000 to 25,000 ha annually. The rate of afforestation which was around 30,000 ha during 1998 has declined since then. The rate of afforestation during 2003-04, the latest year for which data is available, was around 13,414 ha. The budget allocation of the state government to A&R programmes has declined over the years (State Budget) reflected by the reduction in area afforested in the recent years. The proposed A&R under CDM is being undertaken under different circumstances; Changes in state afforestation policies, reduction in budget allocation for A&R and intensification of forestry practices compared to the normal A&R programme of the forest department. A comparative analysis of the previous and ongoing A&R



**PROJECT DESIGN DOCUMENT FORM  
FOR AFFORESTATION AND REFORESTATION PROJECT ACTIVITIES (CDM-AR-PDD) - Version 05**

activities with the proposed A/R CDM activity in Himachal Pradesh shows the following differences which make the proposed project different and is not common practice.

1. *Maintenance of reforested areas:* In the normal A/R programmes of the state, there is no budget provision for carrying out forest maintenance activities. But, using the CDM revenue, forest plantation maintenance activities will be implemented to increase the survival rates and biomass growth rate of plantations.
2. *Inclusion of private abandoned land:* State funded A/R programmes are not implemented on degraded private land. The land owners have little financial incentive to invest in afforestation programmes on their land, due to long gestation period and low economic returns.
3. *Lack of financial incentives for communities under the normal A/R programmes:* Given the low economic returns, panchayats do not have any financial incentive to undertake or participate in reforestation on degraded lands.
4. *Incentive of carbon revenue for community participation for watershed protection, biodiversity conservation and carbon sequestration:* Carbon revenue would make the reforestation programme financially viable and attractive to the panchayats as well as individual farmers, providing incentives for their participation.
5. *Financial barriers to A/R programmes:* The budget allocation of the state government to afforestation programmes has declined.
6. *Species choice:* In Himachal Pradesh, the dominant species promoted under the A/R programmes include pines, oaks and *Acacia catechu*. Conversely, the proposed A/R CDM project promotes multi-species forestry, economically useful to the communities. For example, native fruit yielding tree species are preferred on degraded abandoned private lands.
7. *Decline of external funding to forest management programmes:* Funding for forestry programmes has declined and currently, no programmes exist. The GTZ and DFID funded afforestation programmes in Himachal Pradesh have ended and currently no state-wide externally funded afforestation programme exists.
8. *Improved silvicultural practices:* The proposed A/R CDM project aims to adopt planting of healthy seedlings, improved land preparation and protection measures. These practices increase the cost of planting per hectare beyond the norms of the state Forest Department<sup>16</sup>. Raising seedlings and transportation of seedlings to the planting sites involves significant human effort and cost. Thus the area proposed for the A/R CDM project is unlikely to be planted under the normal A&R programmes.

*Difficult terrain:* The dominant area proposed for the A/R CDM project is degraded forestland accounting for over 70% of the total area to be reforested. This land is at a higher elevation, away from the settlements and with inadequate access. Normal afforestation programmes will occur in the easily accessible area in the lower reaches of the hills.

**C.7. Estimation of the *ex ante* baseline net GHG removals by sinks:**

Under the applicability conditions of this methodology:

<sup>16</sup> June 2008 MHWDP Executive Committee proceedings

## CDM – Executive Board

**PROJECT DESIGN DOCUMENT FORM  
FOR AFFORESTATION AND REFORESTATION PROJECT ACTIVITIES (CDM-AR-PDD) - Version 05**

- Changes in carbon stock of aboveground and below-ground biomass of non tree vegetation may be conservatively assumed to be zero for all strata in the baseline scenario;
- It is expected that the baseline dead wood and litter carbon pools will not show a permanent net increase. It is therefore conservative to assume that the sum of the changes in the carbon stocks of dead wood and litter carbon pools is zero for all strata in the baseline scenario;
- Changes in carbon stock in soil organic carbon may be conservatively assumed to be zero for all strata in the baseline scenario.

Therefore the baseline net GHG removals by sinks will be determined as:

$$\Delta C_{BSL} = \Delta C_{BSL,tree} \quad (1)$$

where:

$\Delta C_{BSL}$                       Baseline net greenhouse gas removals by sinks; t CO<sub>2</sub>-e

$\Delta C_{BSL,tree}$                 Sum of the carbon stock changes in above-ground and below-ground biomass of trees in the baseline; t CO<sub>2</sub>-e

As demonstrated in Section A.7, the baseline scenario is the continued degradation of carbon stocks or their maintenance in a steady state, under which the carbon stock changes in dead wood and litter are conservatively assumed to be zero. There are pre-project growing trees, thus the baseline net removals by sinks are estimated as the sum of the carbon stock change due to the growth of pre-project growing trees. See Annex 3 for detailed estimation.

Biomass projections of growing stock are estimated using the gain-loss method. In the absence of literature on biomass growth rate or mean annual increment in degraded forests, the following approach has been adopted to estimate the mean annual increment as a function of total growing stock. The steps in calculation of increment in growing stock are detailed in Box C.7.1.

**Box C.7.1:** Steps in calculation of mean annual increment for baseline carbon stocks

Area under forests in Himachal Pradesh for which growing stock data is compiled	543,200 ha
Total GS in for the area-543,200 ha	100,102,000 m <sup>3</sup>
Total annual growth rate (yield) for 543,200 ha	696,800 m <sup>3</sup>
BEF	1.2
Total annual growth rate (yield) of AGB for 543,200 ha	836,160 m <sup>3</sup>
R:S ratio	0.24
Total growth rate (AGB+BGB)	836,160 + 200,678 = 1,036,838 m <sup>3</sup>
Growth rate per ha of AGB + BGB	1,036,838 m <sup>3</sup> /543,200 ha = 1.91 m <sup>3</sup> /ha/yr
Per hectare growing stock – Aboveground biomass	100,102,000m <sup>3</sup> /543,200 ha = 184.28 m <sup>3</sup> /ha
BEF (IPCC, 2006)	1.2
Total aboveground biomass	221.14 m <sup>3</sup> /ha
R:S ratio (GPG, 2003)	0.24
Total biomass (AGB+BGB)	221.14 + 53.07 = 274.21 m <sup>3</sup> /ha
Mean annual increment factor as a function of GS (ratio)	1.91m <sup>3</sup> /ha/yr / 274.21m <sup>3</sup> /ha = 0.007



**PROJECT DESIGN DOCUMENT FORM  
FOR AFFORESTATION AND REFORESTATION PROJECT ACTIVITIES (CDM-AR-PDD) - Version 05**

<i>of total annual yield to total growing stock per hectare)</i>	
Per hectare yield or MAI or growth rate	696,800 m <sup>3</sup> /543,200 ha = 1.28 m <sup>3</sup> /ha
Mean annual increment factor as a function of GS (Per hectare MAI/Per ha GS)	0.007

The losses are likely to be abysmally small since mean annual increment per hectare itself is only 0.007 m<sup>3</sup>/ha/yr or 0.004 t/ha/year (0.007 X 0.57 (wood density - regional default for tropical species, see Reyes et al (1992)<sup>17</sup>, Brown, 1997)<sup>18</sup>.

The net GHG removals, which include carbon in above and belowground biomass, are estimated for the three land categories (degraded forest, community and private land) under the baseline scenario using plot method, involving harvest method for non-tree vegetation. The plot method is described in Annex 4. The aboveground tree biomass of trees is determined by measuring DBH and height of trees and estimation of volume using species-specific biomass equations for the dominant tree species. Belowground biomass is estimated using the IPCC default conversion factor of 0.24 (GPG, 2003) fraction of aboveground biomass. The average biomass (AGB+BGB) on different land categories selected for the A/R CDM project, based on field studies is given in Table C.7.1. The non-tree biomass was estimated by adopting harvest method (Refer to Table C.7.1).

**Table C.7.1:** Average biomass stock (or growing stock) per hectare in different land categories in tC/ha under baseline conditions

Land category	Total tree biomass (t/ha)	Total non-tree biomass (t/ha)	Total aboveground biomass (t/ha)
Degraded forestland	1.55	1.70	3.25
Degraded community land	1.49	1.30	2.79
Degraded and abandoned private land	1.76	2.00	3.76
Mean	<b>1.60</b>	<b>1.67</b>	<b>3.27</b>

The average growing stock (for all land categories) under the baseline scenario for the proposed area to be reforested is 3.27 tons of biomass per hectare. Thus, the mean annual increment in the baseline carbon stock of tree and non-tree biomass is likely to be insignificant (0.013 t/ha/yr) and therefore not included in the ex-ante baseline net GHG removals by sinks as per the methodology guideline.

The ex ante baseline net GHG removal by sinks accounting for above and belowground biomass over a 20-year period is insignificant and therefore not accounted for.

Year	Annual estimation of baseline net anthropogenic GHG removals by sinks in tonnes of CO <sub>2</sub> e
------	--

<sup>17</sup> Reyes, G., S. Brown, J. Chapman, and A. E. Lugo (1992). *Wood densities of tropical tree species*. USDA Forest Service, General Technical Report SO-88, Southern Forest Experiment Station, New Orleans, Louisiana, USA

<sup>18</sup> Brown, S. 1997. *Estimating Biomass and Biomass Change of Tropical Forests: a Primer*. FAO Forestry Paper 134, Rome, Italy



**PROJECT DESIGN DOCUMENT FORM  
FOR AFFORESTATION AND REFORESTATION PROJECT ACTIVITIES (CDM-AR-PDD) - Version 05**

2006	-
2007	-
2008	-
2009	-
2010	-
2011	-
2012	-
2013	-
2014	-
2015	-
2016	-
2017	-
2018	-
2019	-
2020	-
2021	-
2022	-
2023	-
2024	-
2025	-
<b>Total estimated baseline net GHG removals by sinks (tonnes of CO<sub>2</sub> e)</b>	-
<b>Total number of crediting years</b>	-
<b>Annual average over the crediting period of estimated baseline net GHG removals by sinks (tonnes of CO<sub>2</sub> e)</b>	

Data and parameters (*pertaining to ex-ante estimation of baseline*) that are available at **validation**:

<b>Data / Parameter:</b>	$A_{BSL,i}$
Description/unit:	Area of baseline stratum i / ha
Value applied:	Baseline stratum 1 (degraded forest land) – 3176.86 ha; Baseline stratum 2 (degraded community land) – 293.06 ha; Baseline stratum 3 (degraded agricultural land) – 533.15 ha;
Source of data:	GPS coordinates; official records
Justification of choice / Measurement procedures (if any):	The GPS coordinates and official records are used to assess the area of baseline strata.
Any comment:	

<b>Data / Parameter:</b>	$I_{V,i,t}$
--------------------------	-------------



**PROJECT DESIGN DOCUMENT FORM  
FOR AFFORESTATION AND REFORESTATION PROJECT ACTIVITIES (CDM-AR-PDD) - Version 05**

Description/unit:	Average annual increment in volume of species $j$ in stratum $i$ for year $t$ ; $m^3 \text{ ha}^{-1} \text{ yr}^{-1}$
Value applied:	1.28
Source of data:	Local forest inventory; official records
Justification of choice / Measurement procedures (if any):	The average annual increment has been calculated based on the published growth data of the species. The value applied is therefore conservative.
Any comment:	

<b>Data / Parameter:</b>	$BEF_{i,j}$
Description/unit:	Biomass expansion factor for conversion of annual net increment (including bark) in stem biomass to total above-ground tree biomass increment for species $j$ /Dimensionless
Value applied:	1.2
Source of data:	IPCC (2003) GPG LULUCF, Table 3A.1.10
Justification of choice / Measurement procedures (if any):	The lower value of BEF referenced in the IPCC (2003) GPG LULUCF, Table 3A.1.10 is applied for conversion of stem biomass to above-ground tree biomass in the project.
Any comment:	

<b>Data / Parameter:</b>	$R_i$
Description/unit:	Root-shoot ratio for tree species or group of species $j$ / $\text{kg d.m.yr}^{-1} (\text{kg d.m.yr}^{-1})^{-1}$
Value applied:	0.24
Source of data:	IPCC GPG 2003, Table 3A.1.8
Justification of choice / Measurement procedures (if any):	The mean value of the root-shoot ratio for tropical and sub-tropical forest, referenced in the IPCC (2003) GPG LULUCF, Table 3A.1.8 has been chosen for conversion of stem biomass to above-ground tree biomass of tree species included in the project.
Any comment:	

<b>Data / Parameter:</b>	$D_j$
Description/unit:	Basic wood density for species $j$ / $\text{t d.m. m}^{-3}$
Value applied:	0.57
Source of data:	Reyes, G., S. Brown, J. Chapman, and A. E. Lugo (1992). <i>Wood densities of tropical tree species. USDA Forest Service, General Technical Report SO-88</i> , Southern Forest Experiment Station, New Orleans, Louisiana, USA. Brown, S (1997). <i>Estimating Biomass and Biomass Change of Tropical Forests: a Primer</i> . FAO Forestry Paper 134, Rome, Italy
Justification of choice / Measurement procedures (if any):	The average wood density value of tree species of tropical forests of Asia is adopted for the <i>ex ante</i> estimation of GHG removals by sinks.
Any comment:	



**PROJECT DESIGN DOCUMENT FORM  
FOR AFFORESTATION AND REFORESTATION PROJECT ACTIVITIES (CDM-AR-PDD) - Version 05**

<b>Data / Parameter:</b>	CF <sub>i</sub>
<b>Description/unit:</b>	Carbon fraction of dry matter for species of type <i>j</i> / t C t <sup>-1</sup> d.m.
<b>Value applied:</b>	0.5
<b>Source of data:</b>	IPCC GPG LULUCF (2003)
<b>Justification of choice / Measurement procedures (if any):</b>	Default value
<b>Any comment:</b>	

TABLE 3A.1.10 DEFAULT VALUES OF BIOMASS EXPANSION FACTORS (BEFs) (BEF <sub>2</sub> to be used in connection with growing stock biomass data in Equation 3.2.3; and BEF <sub>1</sub> to be used in connection with increment data in Equation 3.2.5)				
Climatic zone	Forest type	Minimum dbh (cm)	BEF <sub>2</sub> (overbark) to be used in connection to growing stock biomass data (Equation 3.2.3)	BEF <sub>1</sub> (overbark) to be used in connection to increment data (Equation 3.2.5)
Boreal	Conifers	0-8.0	1.35 (1.15-3.8)	1.15 (1-1.3)
	Broadleaf	0-8.0	1.3 (1.15-4.2)	1.1 (1-1.3)
Temperate	Conifers: Spruce-fir	0-12.5	1.3 (1.15-4.2)	1.15 (1-1.3)
	Pines	0-12.5	1.3 (1.15-3.4)	1.05 (1-1.2)
	Broadleaf	0-12.5	1.4 (1.15-3.2)	1.2 (1.1-1.3)
Tropical	Pines	10.0	1.3 (1.2-4.0)	1.2 (1.1-1.3)
	Broadleaf	10.0	3.4 (2.0-9.0)	1.5 (1.3-1.7)

Note: BEFs given here represent averages for average growing stock or age, the upper limit of the range represents young forests or forests with low growing stock; lower limits of the range approximate mature forests or those with high growing stock. The values apply to growing stock biomass (dry weight) including bark and for given minimum diameter at breast height; Minimum top diameters and treatment of branches is unspecified. Result is above-ground tree biomass.

Sources: Isaev *et al.*, 1993; Brown, 1997; Brown and Schroeder, 1999; Schoene, 1999; ECE/FAO TBFRA, 2000; Lowe *et al.*, 2000; please also refer to FRA Working Paper 68 and 69 for average values for developing countries (<http://www.fao.org/forestry/index.jsp>)



**PROJECT DESIGN DOCUMENT FORM  
FOR AFFORESTATION AND REFORESTATION PROJECT ACTIVITIES (CDM-AR-PDD) - Version 05**

**TABLE 3A.1.8  
AVERAGE BELOWGROUND TO ABOVEGROUND BIOMASS RATIO (ROOT-SHOOT RATIO, R) IN NATURAL REGENERATION BY  
BROAD CATEGORY (tonnes dry matter/tonne dry matter)  
(To be used for R in Equation 3.2.5)**

	Vegetation type	Aboveground biomass (t/ha)	Mean	SD	lower range	upper range	References
Tropical/sub-tropical forest	Secondary tropical/sub-tropical forest	<125	0.42	0.22	0.14	0.83	5, 7, 13, 25, 28, 31, 48, 71
	Primary tropical/sub-tropical moist forest	NS	0.24	0.03	0.22	0.33	33, 57, 63, 67, 69
	Tropical/sub-tropical dry forest	NS	0.27	0.01	0.27	0.28	65
Conifer forest/plantation	Conifer forest/plantation	<50	0.46	0.21	0.21	1.06	2, 8, 43, 44, 54, 61, 75
	Conifer forest/plantation	50-150	0.32	0.08	0.24	0.50	6, 36, 54, 55, 58, 61
	Conifer forest/plantation	>150	0.23	0.09	0.12	0.49	1, 6, 20, 40, 53, 61, 67, 77, 79
Temperate broadleaf forest/plantation	Oak forest	>70	0.35	0.25	0.20	1.16	15, 60, 64, 67
	Eucalypt plantation	<50	0.45	0.15	0.29	0.81	9, 51, 59
	Eucalypt plantation	50-150	0.35	0.23	0.15	0.81	4, 9, 59, 66, 76
	Eucalypt forest/plantation	>150	0.20	0.08	0.10	0.33	4, 9, 16, 66
	Other broadleaf forest	<75	0.43	0.24	0.12	0.93	30, 45, 46, 62
	Other broadleaf forest	75-150	0.26	0.10	0.13	0.52	30, 36, 45, 46, 62, 77, 78, 81
	Other broadleaf forest	>150	0.24	0.05	0.17	0.30	3, 26, 30, 37, 67, 78, 81
Grassland	Steppe/tundra/prairie grassland	NS	3.95	2.97	1.92	10.51	50, 56, 70, 72
	Temperate/sub-tropical/ tropical grassland	NS	1.58	1.02	0.59	3.11	22, 23, 32, 52
	Semi-arid grassland	NS	2.80	1.33	1.43	4.92	17-19, 34
Other	Woodland/savanna	NS	0.48	0.19	0.26	1.01	10-12, 21, 27, 49, 65, 73, 74
	Shrubland	NS	2.83	2.04	0.34	6.49	14, 29, 35, 38, 41, 42, 47, 67
	Tidal marsh	NS	1.04	0.21	0.74	1.23	24, 39, 68, 80

NS = Not specified

Source: ([http://www.ipcc-nggip.iges.or.jp/public/gpplulucf/gpplulucf\\_files/Chp3/Anx\\_3A\\_1\\_Data\\_Tables.pdf](http://www.ipcc-nggip.iges.or.jp/public/gpplulucf/gpplulucf_files/Chp3/Anx_3A_1_Data_Tables.pdf))

**SECTION D. Estimation of *ex ante* actual net GHG removals by sinks, leakage, and estimated amount of net anthropogenic GHG removals by sinks over the chosen crediting period**

**D.1. *Ex ante* estimation of actual net GHG removals by sinks:**

>>

The *ex ante* net GHG removals by sinks are calculated for a crediting period of 20 years using the approach provided in the methodology AR-ACM0001, Version 03, annually for different carbon pools and expressed as tonnes of CO<sub>2</sub>-equivalent. The GHG emissions from biomass burning during site preparation is estimated and deducted from the sum of the changes in carbon stocks of all the pools to obtain the actual net GHG removals by sinks. The procedure adopted for estimating the *ex ante* actual net GHG removals by sinks is given below:

*Actual net greenhouse gas removals by sinks (C<sub>ACTUAL</sub>):* This is estimated by calculating the sum of changes in living biomass carbon stocks and soil carbon and deducting the sum of the emissions by sources within the project boundary, as a result of project activities using the following formula (Equation 12 of AR-ACM0001):

$$C_{ACTUAL} = \Delta C_P - GHG_E$$

where:

$C_{ACTUAL}$  = actual net greenhouse gas removals by sinks; t CO<sub>2</sub>-e.



**PROJECT DESIGN DOCUMENT FORM  
FOR AFFORESTATION AND REFORESTATION PROJECT ACTIVITIES (CDM-AR-PDD) - Version 05**

$\Delta C_P$  = sum of the changes in aboveground and below-ground biomass, dead wood, litter and soil organic carbon stocks in the project scenario; t CO<sub>2</sub>-e

$GHG_E$  = sum of the increases in GHG emissions by sources within the project boundary as a result of the implementation of an AR CDM project activity; t CO<sub>2</sub>-e.

*Estimation of changes in the carbon stocks*

The changes in carbon stock in tree aboveground and belowground biomass and soil organic carbon was estimated in the following manner<sup>19</sup> as per AR-ACM0001 requirements.

$$\Delta C_P = \sum_{t=1}^{t^*} \Delta C_t * \frac{44}{12} * 1year - E_{BiomassLoss}$$

Where:

$\Delta C_P$ : Sum of the changes in aboveground and below-ground biomass and soil organic carbon stocks in the project scenario; t CO<sub>2</sub>-e

$\Delta C_t$ : Annual change in carbon stock in all selected carbon pools for year  $t$ ; t C yr<sup>-1</sup>

$E_{BiomassLoss}$ : Increase in CO<sub>2</sub> emissions from loss of existing biomass due to site-preparation (including burning), and/or to competition from forest (or other vegetation) planted as part of the A/R CDM project activity; t CO<sub>2</sub>

$T$ : 1, 2, 3, ...  $t^*$  years elapsed since the start of the AR project activity; yr

44/12: Ratio of molecular weights of CO<sub>2</sub> and carbon; t CO<sub>2</sub> t<sup>-1</sup> C

$E_{BiomassLoss}$  is estimated using the most recent version of the approved methodological tool: “Estimation of emissions from clearing, burning and decay of existing vegetation due to implementation of a CDM A/R project activity<sup>20</sup>”.

$\Delta C_t$  shall be estimated using the following equation:

$$\Delta C_t = \sum_{i=1}^{MPS} (\Delta C_{AG,i,t} + \Delta C_{BG,i,t} + \Delta C_{DW,i,t} + \Delta C_{LI,i,t} + \Delta C_{SOC,i,t})$$

$\Delta C_{LI,i,t}$  Annual change in the litter carbon pool in stratum  $i$ , (possibly averaged over a monitoring period); t C yr<sup>-1</sup>

$\Delta C_{SOC,i,t}$  Annual carbon stock change in the soil organic carbon pool<sup>5</sup> for stratum  $i$ , time  $t$ ; t C yr<sup>-1</sup>

$i$  1, 2, 3, ...  $MPS$  strata in the project scenario

$t$  1, 2, 3, ...  $t$  years elapsed since the start of the A/R CDM project activity

Changes in the carbon pools that are conservatively excluded from accounting shall be set equal to zero.

*Carbon pools included:* Estimates of actual net GHG removals by sinks include carbon stock changes in living biomass (above and belowground biomass) and soil organic carbon. The carbon stock changes in

<sup>19</sup>IPCC GPG-LULUCF 2003, equation 3.2.3

<sup>20</sup> <http://cdm.unfccc.int/methodologies/ARmethodologies/tools/ar-am-tool-08-v2.pdf>



**PROJECT DESIGN DOCUMENT FORM  
FOR AFFORESTATION AND REFORESTATION PROJECT ACTIVITIES (CDM-AR-PDD) - Version 05**

pools of dead wood and litter are excluded. The rationale for selecting these three pools and for excluding dead wood and litter is given in Section C.3.

### **Steps for calculating the carbon stock in aboveground and belowground biomass of trees**

The steps of biomass expansion factor (BEF) method of AR-ACM0001 methodology, version 03 is used for calculating the carbon stocks in aboveground and belowground biomass.

**Step 1:** Based on available data, e.g. volume tables (ex ante) and measurements (ex post) of the diameter at breast height (DBH, at typically 1.3 m above-ground level), and preferably height (H), of trees above some minimum DBH in the permanent sample plots are to be conducted.

**Step 2:** The volume of commercial (merchantable) component of trees is assessed based on volume equations or yield tables (if locally derived equations or yield tables are not available use relevant regional, national or default data as appropriate). It is possible to combine Steps 1 and 2 if there are field instruments (e.g. a relascope) that measure tree volume directly.

Steps 1 and 2 above outline the procedures for estimating commercial (merchantable) component of trees. However, majority of species included in the project do not have volume tables. Thus, aboveground commercial biomass is determined using the procedure described below. The CAI/MAI values required for the calculation of merchantable aboveground commercial biomass are assessed using the procedure outlined (a-e) below.

#### ***a) Grouping of tree species based on their growth patterns***

Grouping of species was done based on their growth behavior. For the purpose, the CAI/MAI data on species included in the project was collected. Species for which CAI/MAI values are not available are grouped with species with similar growth characteristics and for which growth rate data are available. The expert opinion of the staff of the Forest Department of Himachal Pradesh was also taken into account in categorizing the species.

#### ***b) Literature search for CAI and MAI values for species included in stand models***

Literature search on CAI/MAI values of the species included in the stand models was conducted. The CAI values were available only for some of the species. MAI values were used for species that did not have CAI values. Species for which no CAI/MAI values were available, data of related species (from same genus) or species with similar growth characteristics was used.

- i) Literature survey revealed that CAI values were available for several species. However, CAI data were not available for different age classes
- ii) For some species, different growth rates were reported in the literature (eg. Table D1 as an illustration)

#### ***c) Selection of growth rates for calculating/estimating net GHG removal***

The selection of CAI/MAI for the project was done taking into account the following:

- iii) Three stand models implemented on three land categories.
  - a. Restoration forestry on degraded forestland
  - b. Community forestry on degraded community land
  - c. Farm forestry on degraded and abandoned private land
- iv) Each stand model is further stratified into three altitude classes



**PROJECT DESIGN DOCUMENT FORM  
FOR AFFORESTATION AND REFORESTATION PROJECT ACTIVITIES (CDM-AR-PDD) - Version 05**

- a. High – 1400 to 1800 m
- b. Medium – 1100 to 1400 m
- c. Low – 600 to 1100 m
- v) Stand model in each altitude class (e.g. restoration high altitude) is further grouped into slow or fast growing based on the growth rate of aboveground biomass.
  - a. Fast growing species (>5t/ha/yr)
  - b. Slow growing species (<5t/ha/yr)
- vi) The fast/slow category consists of multiple species, e.g., high altitude\_fast growing species under reforestation model\_- *Alnus nitida*, *Juglans regia*, *Populus ciliata*, *Quercus leucotricophora*, *Robinia pseudoacacia*, *Salix alba*. and *Toona ciliate*

**Table D1:** CAI according to different age and study – An example of data reported for *Pinus roxburghii* in literature

Age	<5	5-10	11-20	21-30	Reference
6		4.70			J.K. Rawat, V. N.Tandon (1993), Biomass production and mineral cycling in young Chir Pine plantations in Himachal Pradesh, Indian Forester, December
10		7.91			
14			5.93		
16			4.18		
18			4.69		
10		4.91			S.K. Suri (1984), Growth analysis of Chir( <i>Pinus roxburghii</i> , sargent) plantations in Supkhar of Balaghat division of Madhya Pradesh, Indian Forester, May
15			4.21		
15			4.68		
15			5.12		
20			4.54		
20			5.51		
25				4.77	
25				5.09	
25				5.83	
30				4.91	
30				5.46	
30				5.97	
10		5.42			
10		4.91			
15			5.12		
15			4.69		
20			5.51		
25				5.82	
25				4.78	
30				5.99	

**PROJECT DESIGN DOCUMENT FORM  
FOR AFFORESTATION AND REFORESTATION PROJECT ACTIVITIES (CDM-AR-PDD) - Version 05**

**d) Approach adopted for generating CAI/MAI values as input to TARAM spreadsheet model estimating net GHG removal**

- i) Selection of growth rates for the species included in the stand models
  - All the available CAI/MAI values reported in literature for a given species according to age classes (5yrs, 5-10 yrs, 11-20 and >20yrs) were compiled
  - The mean CAI was obtained for each age group from different literature values
  - To ensure conservativeness, CAI value closest to the mean was selected
  - If for some species, CAI/MAI values were not available from literature, values of related species from the same genera were used, e.g., *Populus deltoides* for *Populus ciliata*
  - For some species, no CAI/MAI values were available even for the related genera. E.g., *Ulmus laevigata*. For such species, growth rates of species with similar growth characteristics were chosen.
  
- ii) Compilation of species-wise growth rates for each stand model
  - The CAI values for species selected for different age classes are compiled in Table D 2.

CAI/MAI values for each species and for different age classes were obtained by considering the literature values for the given species and selecting a value immediately lower than the mean value for species and age-class. Searches of the published literature with regard to the biomass growth did not result in suitable growth data and adequate information on some species such as: *Ailanthus excelsa*, *Grewelia robusta*, *Prunus armenica*, *Morus alba*, *Bombax ceiba*, *Ulmus laevigata*, *Bauhinia variegata*, *Sapindus mukorossii*, *Mangifera indica*, *Aegle marmelos*, *Hicoria carya*, *Butea monosperma*, *Olea glandulifera*, *Terminalia bellerica*, *Terminalia chebula*. The expert opinion available at the Forest Research Institute, Dehradun, the Forest Department of Himachal Pradesh and the Indian Institute of Science, Bangalore on characteristics of species and growth behavior was used in the classification of species as slow or fast growing. The expert opinion on growth rates was considered while adopting the conservative growth rates of the slow or fast growing species. The resulting growth rates and the projection of the ex ante GHG removals are therefore conservative.

**Table D 2:** CAI and MAI values from literature for the tree species included in stand models.

Altitude	Growth rate	Species mix	<5	5-10	11-20	Adoption of growth data of species with similar growth rates/expert opinion on species characteristics and growth rates
High (1400-1800m)	Fast	<i>Alnus nitida</i>			5.30	<i>A. nepalensis</i> (22 yrs)
		<i>Juglans regia</i>	10.50			
		<i>Populus ciliata</i>	16.90	10.75		<i>P.deltoides</i>
		<i>Quercus leucotrichophora</i>	16.63			
		<i>Salix alba</i>	0.67	5.80	8.00	
		<i>Toona ciliata</i>			6.33	
		<b>Conservative</b>	<b>10.50</b>	<b>5.80</b>	<b>6.33</b>	
	<i>Mean</i>	11.17	8.27	6.54		
	Slow	<i>Robinia pseudoacacia</i>			3.59	
		<i>Ailanthus excelsa</i>				Expert opinion
		<i>Prunus armenica</i>				Expert opinion
		<i>Aesculus indica</i>	0.32	1.07	3.69	
		<i>Cedrus deodara</i>	0.95			
		<i>Pinus wallichiana</i>		5.42	4.69	<i>P. roxburghii</i>



## CDM – Executive Board

**PROJECT DESIGN DOCUMENT FORM  
FOR AFFORESTATION AND REFORESTATION PROJECT ACTIVITIES (CDM-AR-PDD) - Version 05**

		<i>Conservative</i>	<b>0.32</b>	<b>1.07</b>	<b>3.69</b>	
		<i>Mean</i>	0.64	3.25	3.99	
Medium (1100-1400m)	Fast	<i>Populus ciliata</i>	16.90	10.75		<i>P.deltoides</i>
		<i>Salix alba</i>	0.67	5.80	8.14	
		<i>Albizia procera</i>	4.37	6.58		
		<i>Juglans regia</i>	10.50			
		<i>Dendrocalamus strictus</i>	13.95	14.94		
		<i>Grevillia robusta</i>				Expert opinion
		<i>Quercus leucotrichophora</i>	16.63			
		<i>Morus alba</i>				Expert opinion
		<i>Pinus roxburghii</i>		5.42	4.69	
		<i>Toona ciliata</i>			6.33	
		<i>Bombax ceiba</i>				Expert opinion
		<i>Ulmus laevigata</i>				Expert opinion
		<i>Tectona grandis</i>		5.39	5.43	
		<i>Conservative</i>	<b>4.37</b>	<b>6.58</b>	<b>5.43</b>	
	<i>Mean</i>	10.50	8.15	6.15		
	Slow	<i>Ailanthus excelsa</i>				Expert opinion
		<i>Melia azadirach</i>		4.85		
		<i>Syzygium cuminii</i>	2.23	4.23	5.09	
		<i>Bauhinia variegata</i>				Expert opinion
		<i>Sapindus mukorossii</i>				Expert opinion
		<i>Mangifera indica</i>				Expert opinion
		<i>Aegle marmelos</i>				Expert opinion
		<i>Hicoria carya</i>				Expert opinion
		<i>Prunus armenica</i>				Expert opinion
		<i>Pinus wallichiana</i>		5.42	4.69	<i>P. roxburghii</i>
		<i>Robinia pseudoacacia</i>			3.59	30 yrs
		<i>Grewia optiva</i>				Expert opinion
		<i>Cedrus deodara</i>	0.95			
<i>Conservative</i>		<b>0.95</b>	<b>4.23</b>	<b>3.59</b>		
<i>Mean</i>	1.59	4.83	4.46			
Low (600-1100m)	Fast	<i>Acacia nilotica</i>	13.10	7.21	6.21	
		<i>Albizia procera</i>	4.37	6.58		
		<i>Bombax ceiba</i>				Expert opinion
		<i>Dendrocalamus strictus</i>	13.95	14.94		
		<i>Dalbergia sissoo</i>	6.22	7.78	5.99	
		<i>Emblica officinalis</i>		7.83		
		<i>Morus alba</i>				Expert opinion
		<i>Pongamia pinnata</i>	6.20			
		<i>Populus ciliata</i>	16.90	10.75		<i>P. deltoides</i>
		<i>Salix alba</i>	0.67	5.80	8.14	
	<i>Tectona grandis</i>		5.39	5.43		
	<i>Toona ciliata</i>			6.33		
	<i>Conservative</i>	<b>6.22</b>	<b>7.83</b>	<b>6.33</b>		
	<i>Mean</i>	8.77	8.28	6.42		
	Slow	<i>Acacia catechu</i>		0.84	2.65	
		<i>Aegle marmelos</i>				Expert opinion
		<i>Azadirachta indica</i>	0.42	0.67		
		<i>Bauhinia variegata</i>				Expert opinion
		<i>Butea monosperma</i>				Expert opinion
		<i>Cassia siamia</i>	4.69	1.36		
<i>Grewia optiva</i>					Expert opinion	
<i>Mangifera indica</i>					Expert opinion	
<i>Melia azadirchta</i>		4.85				
<i>Olea glandulifera</i>						



**PROJECT DESIGN DOCUMENT FORM  
FOR AFFORESTATION AND REFORESTATION PROJECT ACTIVITIES (CDM-AR-PDD) - Version 05**

	<i>Syzygium cumini</i>	2.23	4.23	5.09	
	<i>Terminalia arjuna</i>	2.95	2.41		
	<i>Terminalia bellerica</i>				Expert opinion
	<i>Terminalia chebula</i>				Expert opinion
	<b>Conservative</b>	<b>2.23</b>	<b>1.36</b>	<b>2.65</b>	
	<i>Mean</i>	2.57	2.39	3.87	

iii) Selection of representative growth rate to be used for different stand models

The following procedure was adopted to select representative growth rates for each stand model, e.g., high altitude – fast growth rate, from among the CAI values of different species included in the stand model

- All the species for a given stand model for which CAI/MAI values are reported in the literature were considered.
- Mean of the growth rate was estimated for each age class considering all the species for which CAI/MAI values were available for each stand model
- To ensure conservativeness, the CAI/MAI value immediately lower than the mean value for that age class was selected to represent that age class for that stand model.
- Where CAI values are not available for a species and age class of a stand model, MAI values were used.

iv) Compilation of representative growth rates for each age class of each stand model as input into TARAM

The representative CAI/MAI values for each age class of each stand model are compiled in Table D 3. From among the CAI/MAI values for each age class, mean was estimated and a lower value closest to the mean (to ensure conservativeness) is selected and included in this table to represent the respective stand model. Conservativeness is ensured by taking a value lower than the mean CAI/MAI for a given age class.

**Table D 3:** Conservative CAI values obtained from Table D 2.

Altitude	Growth rate	Species mix	<5	5-10	11-20
High (1400-1800m)	Fast growing	<i>Alnus nitida, Juglans regia, Populus ciliata, Quercus leucotrichophora, Salix alba, Toona ciliata</i>	10.50	5.80	6.33
	Slow growing	<i>Ailanthus excelsa, Prunus armenica, Robinia pseudoacacia, Aesculus indica, Cedrus deodara, Pinus wallichiana</i>	0.32	1.07	3.69
Medium (1100-1400m)	Fast growing	<i>Populus ciliata, Salix alba, Tectona grandis, Albizzia procera, Juglans regia, Dendrocalamus strictus, Grevillia robusta, Quercus leucotrichophora, Morus alba, Pinus roxburghii, Toona ciliata, Robinia pseudoacacia, Bombax ceiba, Ulmus laevigata</i>	4.37	6.58	5.43
	Slow growing	<i>Ailanthus excelsa, Melia azadirachta, Syzygium cumini, Bauhinia variegata, Sapindus mukorossii, Mangifera indica, Aegle marmelos, Hicoria carya, Prunus armenica, Pinus wallichiana, Grewia optiva, Cedrus deodara, Robinia pseudoacacia</i>	0.95	4.23	3.59
Low (600-1100m)	Fast growing	<i>Acacia nilotica, Albizzia procera, Bombax ceiba, Dendrocalamus strictus, Dalbergia sissoo, Emblica officinalis, Morus alba, Pongamia pinnata, Populus ciliata, Salix alba, Tectona grandis,</i>	6.22	7.83	6.33



**PROJECT DESIGN DOCUMENT FORM  
FOR AFFORESTATION AND REFORESTATION PROJECT ACTIVITIES (CDM-AR-PDD) - Version 05**

		<i>Toona ciliata</i>			
	Slow growing	<i>Acacia catechu, Aegle marmelos, Azadirchta indica, Bauhinia variegata, Butea monosperma, Cassia siamia, Grewia optiva, Mangifera indica, Melia azadirchta, Olea glandulifera, Syzygium cuminii, Terminalia arjuna, Terminalia bellerica, Terminalia chebula</i>	2.23	1.36	2.65

## v) Preparation of input data on CAI/MAI for TARAM

The CAI and MAI values for each stand model and altitude range, as input to TARAM, are calculated using the following procedure:

- The conservative CAI/MAI for each stand model and ‘fast’ and ‘slow’ growing species group given in Table D 3 from Step-D is considered
- A single CAI value was computed for each stand model (eg. Restoration forestry-high altitude) by considering weighted value based on density (number of trees/ha) for ‘fast’ and ‘slow’ growing species (Table D 4). Thus values in Table D 4 are different from values in Table D 3.

**Table D 4:** CAI/MAI values derived as input to TARAM based on the tree density proportion of fast/slow growing tree species

Stand model	Altitude range	Rate of growth	No. of trees/ha	Fraction of total density	MAI for calculation (t/ha/yr)		
					<5	5-10	11-20
Restoration	High (1400-1800m)	Fast	550	0.5	5.25	2.90	3.17
		Slow	550	0.5	0.16	0.54	1.85
	Total		1100		<b>5.41</b>	<b>3.43</b>	<b>5.01</b>
	Medium (1100-1400m)	Fast	550	0.5	2.19	3.29	2.72
		Slow	550	0.5	0.48	2.11	1.80
	Total		1100		<b>2.66</b>	<b>5.40</b>	<b>4.51</b>
	Low (600-1100m)	Fast	550	0.5	3.11	3.92	3.17
		Slow	550	0.5	1.12	0.68	1.33
	Total		1100		<b>4.23</b>	<b>4.60</b>	<b>4.49</b>
Community forestry	High (1400-1800m)	Fast	550	0.5	5.25	2.90	3.17
		Slow	550	0.5	0.16	0.54	1.85
	Total		1100		<b>5.41</b>	<b>3.43</b>	<b>5.01</b>
	Medium (1100-1400m)	Fast	550	0.5	2.19	3.29	2.72
		Slow	550	0.5	0.48	2.11	1.80
	Total		1100		<b>2.66</b>	<b>5.40</b>	<b>4.51</b>
	Low (600-1100m)	Fast	550	0.5	3.11	3.92	3.17
		Slow	550	0.5	1.12	0.68	1.33
	Total		1100		<b>4.23</b>	<b>4.60</b>	<b>4.49</b>
Farm forestry	High (1400-1800m)	Fast	660	0.6	6.30	3.48	3.80
		Slow	440	0.4	0.13	0.43	1.48
	Total		1100		<b>6.43</b>	<b>3.91</b>	<b>5.27</b>
	Medium (1100-1400m)	Fast	660	0.6	2.62	3.95	3.26
		Slow	440	0.4	0.38	1.69	1.44





## CDM – Executive Board

**PROJECT DESIGN DOCUMENT FORM  
FOR AFFORESTATION AND REFORESTATION PROJECT ACTIVITIES (CDM-AR-PDD) - Version 05**

	Total		1100		3.00	5.64	4.69
	Low (600-1100m)	Fast	660	0.6	3.73	4.70	3.80
		Slow	440	0.4	0.89	0.54	1.06
	Total		1100		4.63	5.24	4.86

The CAI/MAI values for each stand model and altitude range derived from Table D 4 are presented in Table D5.

**Table D5:** CAI and MAI values generated from Table D 4 considering the proportion of fast and slow growing species density

Stand model	Altitude range	MAI for calculation (t/ha/yr)			Average MAI over 20 years
		<5	5-10	11-20	
Restoration	High (1400-1800m)	5.41	3.43	5.01	4.62
	Medium (1100-1400m)	2.66	5.40	4.51	4.19
	Low (600-1100m)	4.23	4.60	4.49	4.44
Community forestry	High (1400-1800m)	5.41	3.43	5.01	4.62
	Medium (1100-1400m)	2.66	5.40	4.51	4.19
	Low (600-1100m)	4.23	4.60	4.49	4.44
Farm forestry	High (1400-1800m)	6.43	3.91	5.27	5.20
	Medium (1100-1400m)	3.00	5.64	4.69	4.45
	Low (600-1100m)	4.63	5.24	4.86	4.91

**e) Estimation of net GHG removals using TARAM**

- Net GHG removals by sinks are estimated by considering the CAI values for different age classes or MAI values, separately for different stand models and altitude classes
- The cumulative growth rates for different stand models and altitude ranges from Year 1-year 30 is given in Table D 6.

**Table D 6:** Biomass accumulation rates used in TARAM, computed using CAI and MAI values from Table D5

	Restoration & Community forestry			Farm forestry		
	High	Medium	Low	High	Medium	Low
1	5.41	2.66	4.23	6.43	3.00	4.63
2	10.82	5.32	8.45	12.86	6.00	9.25
3	16.23	7.98	12.68	19.28	9.01	13.88
4	21.64	10.64	16.91	25.71	12.01	18.50
5	17.16	27.02	22.98	19.53	28.20	26.21
6	20.60	32.43	27.57	23.43	33.84	31.45
7	24.03	37.83	32.17	27.34	39.48	36.69



**PROJECT DESIGN DOCUMENT FORM  
FOR AFFORESTATION AND REFORESTATION PROJECT ACTIVITIES (CDM-AR-PDD) - Version 05**

8	27.46	43.24	36.76	31.24	45.12	41.94
9	30.89	48.64	41.36	35.15	50.76	47.18
10	34.33	54.05	45.95	39.05	56.40	52.42
11	55.11	49.61	49.39	58.02	51.63	53.44
12	60.12	54.12	53.88	63.29	56.33	58.30
13	65.13	58.63	58.37	68.56	61.02	63.16
14	70.14	63.14	62.86	73.84	65.72	68.01
15	75.15	67.65	67.35	79.11	70.41	72.87
16	80.16	72.16	71.84	84.39	75.10	77.73
17	85.17	76.67	76.33	89.66	79.80	82.59
18	90.18	81.18	80.82	94.94	84.49	87.45
19	95.19	85.69	85.31	100.21	89.19	92.31
20	100.20	90.20	89.80	105.48	93.88	97.16
21	105.21	94.71	94.29	110.76	98.57	102.02
22	110.22	99.22	98.78	116.03	103.27	106.88
23	115.23	103.73	103.27	121.31	107.96	111.74
24	120.24	108.24	107.76	126.58	112.66	116.60
25	125.25	112.75	112.25	131.85	117.35	121.45
26	130.26	117.26	116.74	137.13	122.04	126.31
27	135.27	121.77	121.23	142.40	126.74	131.17
28	140.28	126.28	125.72	147.68	131.43	136.03
29	145.29	130.79	130.21	152.95	136.13	140.89
30	150.30	135.30	134.70	158.23	140.82	145.75

**Step 3: Choice of biomass expansion factor (BEF) and root-shoot ratio (*R*)**

i) Biomass expansion factor (BEF) parameter - the following procedure was adopted to select the BEF values as an input to TARAM.

- Literature search was conducted for obtaining BEF values for species included in the stand models.
- Literature values for BEF were available for 17 species from among the species included in the stand models
- BEF values were calculated using different component-wise (commercial biomass, branches, foliage and reproductive parts) biomass values.
- The mean BEF value for the 17 species for which literature values are available is 1.98, the range being 1.49-2.90.

However to ensure conservativeness and considering that the literature values are not available for some species, the IPCC default BEF value of 1.2 (IPCC GPG 2003, Table 3.A.1.10) is used as input to TARAM calculations to estimate the net GHG removals by sinks.

ii) Root-shoot ratio - The following procedure was adopted to select the root-shoot ratio parameter as an input to TARAM.



**PROJECT DESIGN DOCUMENT FORM  
FOR AFFORESTATION AND REFORESTATION PROJECT ACTIVITIES (CDM-AR-PDD) - Version 05**

- Literature search was conducted for obtaining R:S values for the species included in the stand models.
- Literature values for R:S were available for 13 species from among the species included in the stand models
- The mean R:S value for the 13 species for which literature values are available is 0.22, the range being 0.17-0.39.
- The average R:S value of 0.22 is used as input to TARAM calculations to estimate the net GHG removals by sinks.

**Step 4: Conversion of** stem volume of trees into above-ground carbon stock via wood density, BEF and carbon fraction.

The above ground commercial biomass values presented in Table D5 (CAI/MAI in tonnes of biomass reported in literature is the product of commercial volume and wood density. Data on wood density of species is provided in the attached excel sheet [*HP Project\_Growth and Expansion factor parameters with reference (Attachment 29).xls*]. This is used as input to the TARAM model, which converts to total above carbon stock using BEF and carbon fraction values.

**Step 5:** Conversion of the carbon stock in above-ground biomass to carbon stock in below-ground using root-shoot ratio

The root-shoot ratio (R:S) parameter input in the TARAM model is used to convert the above ground carbon stock into below ground carbon stock.

**Step 6:** Calculation of carbon stock in above-ground and below-ground biomass of all trees present in plot

The total carbon stock (above ground and below ground) is estimated by summing carbon stock of trees of all species present on the sample plot.

**Step 7:** Calculation of the mean carbon stock in tree biomass for each stratum

Carbon stock of plot is used to calculate the carbon stock of stratum., which is converted into CO<sub>2</sub> equivalent (by multiplying the molecular weights of CO<sub>2</sub> and carbon- 44/12) in the TARAM model.

Conservativeness of the carbon stock of the project using BEF method is ensured by adopting:

- CAI/MAI values for commercial biomass lower than the mean value for each age class in a stand model
- Lower BEF value than the mean BEF value obtained from literature

Harvesting is not considered for the crediting period as the dominant species included in the three reforestation models are long rotation timber or NTFP yielding species with harvesting not envisaged during the crediting period.

#### ***Soil Organic Carbon***

According to AR-ACM0001, Version 3, the changes in soil organic carbon stocks may be assessed using the default method or the changes may conservatively be neglected for ex ante estimations and for ex post estimations, the changes in stocks of soil organic carbon may be assessed using the default method.



**PROJECT DESIGN DOCUMENT FORM  
FOR AFFORESTATION AND REFORESTATION PROJECT ACTIVITIES (CDM-AR-PDD) - Version 05**

The default method is used to account soil organic carbon pool as per the AR-ACM0001, version 03 methodology, as the land included under the A/R CDM project satisfies the following conditions:

- i. The area does not include organic soils (e.g., peat-lands), or wetlands
  - a. Organic soils are absent in the districts of Himachal Pradesh and therefore not an issue.
- ii. Removal of existing vegetation during site preparation for the A/R CDM project activity shall not occur on more than 10% of the area, unless it can be demonstrated that land clearance, e.g., by slash-and-burn activities, is a common practice in the region in which the project is located
  - a. The silvicultural practices adopted for A/R in Himachal Pradesh do not involve slash and burn practices during land preparation. In the proposed A/R CDM project, above ground non-tree vegetation would be cleared at about 0.158 m<sup>2</sup>/plant, which accounts for about 1.7% of the land area per hectare. Further, lantana the dominant shrub species is present in an area of only about 20% of the total project area. Thus, the total area with lantana cover that will be disturbed will account for only 0.035% of the area per hectare.
- iii. Litter shall remain on site and not be removed
  - a. Leaf litter fall from trees planted in the A/R CDM project area will not be removed.
- iv. Ploughing/ripping/scarification associated with site preparation for planting, seeding and/or the human-induced promotion of natural seed sources, shall not exceed 10% of the project area (during each occasion) Site preparation in the project area involves clearing of weeds from an area of about 0.06 m<sup>2</sup> for each seedling and digging pits of 45x45x45cm. Traditionally pit size adopted for all species is 30x30x30cm. Clearing of existing shrubs and weeds will be restricted to only the pit area of the seedling (0.06 m<sup>2</sup> per pit). The plants in the remaining area will not be disturbed. The total area to be disturbed per hectare will be insignificant at around 70 m<sup>2</sup>/ha (0.007% per ha). Ploughing of land prior to planting is not a practice adopted in the project area,
- v. If ploughing/ripping/scarification is used for site preparation, it shall follow the land contour
  - a. Ploughing of land prior to planting is not a practice adopted in the project area,

The entire project area of 4003.07 ha, included in the project boundary satisfies all the conditions listed above and therefore changes in soil organic carbon pool will be estimated using the default method. A default values of  $\Delta C = 0.5 \text{ t C ha}^{-1} \text{ yr}^{-1}$  and  $t_{equilibrium} = 20$  years shall be used as outlined in Version 03 of AR-ACM0001 methodology.

*Step 2: Sum of the increases in GHG emissions by sources within the project boundary as a result of the implementation of the A/R CDM project activity - GHGE*

$$GHG_E = \sum_{t=1}^{t^*} E_{BiomassBurn,t}$$

where:

$GHG_E$  Increase in GHG emissions as a result of the implementation of the proposed A/R CDM project activity within the project boundary; t CO<sub>2</sub>-e

$E_{BiomassBurn,t}$  Non-CO<sub>2</sub> emissions due to biomass burning of existing woody vegetation as part of site preparation during the year  $t$ ; t CO<sub>2</sub>-e

$t$  1, 2, 3, ...  $t^*$  years elapsed since the start of the A/R CDM project activity



**PROJECT DESIGN DOCUMENT FORM  
FOR AFFORESTATION AND REFORESTATION PROJECT ACTIVITIES (CDM-AR-PDD) - Version 05**

The GHG emission sources considered according to Equation 33 of AR-ACM0001, Version 03 methodology include the following:

- GHG emissions resulting from biomass burning within the project boundary during site preparation
  - o The silvicultural practices adopted for A/R in Himachal Pradesh do not involve slash and burn practices during land preparation.
  - o Thus, GHG emissions resulting from biomass burning is considered to be zero.
- Therefore  $GHG_E = \text{Zero}$

Fire management plan is implemented to protect the project area from fires. In case of occurrence of natural fires, the area of stratum and stands affected are surveyed and reported.

*Step 3: Estimation of actual net greenhouse gas removals by sinks – C<sub>ACTUAL</sub>*

The total actual net GHG removals by sinks calculated for the total project area over a 20-year crediting period is 828,016 tCO<sub>2</sub>-e. This is about 207 tCO<sub>2</sub>-e sequestered per hectare of land.

*Actual net greenhouse gas removals by sinks (C<sub>ACTUAL</sub>):* This is estimated by calculating the sum of changes in living biomass carbon stocks and deducting the sum of emissions by sources within the project boundary, as a result of project activities. The actual net GHG removal by sinks is 828,016 tCO<sub>2</sub>-e.

**D.2. Ex ante estimation of leakage:**

>>

Leakage is the increase in GHG emissions by sources which occurs outside the boundary of an A/R CDM project activity which is measurable and attributable to the A/R CDM project activity.

$$LK = LK_{\text{Activity Displacement}}$$

where:

$LK_{\text{ActivityDisplacement}}$  Leakage due to activity displacement; t CO<sub>2</sub>-e

$LK_{\text{Conversion}}$  Leakage due to conversion of land to grazing land; t CO<sub>2</sub>-e

“Tool for estimation of GHG emissions related to displacement of grazing activities in an A/R CDM project activity (version 02)” is used to assess leakage associated with the project. Based on the assessment, the leakage due to conversion of land for grazing is **zero** ( $LK_{\text{grazing}} = 0$ ).

The following information is considered in assessing the leakage to be **zero**.

1. The information on grazing, fodder collection and stall-feeding activities of livestock practiced in the project area.
2. The total livestock population belonging to different livestock groups obtained through PRA in the sample GPs
3. The number and percentage of grazing in different land categories selected for the project obtained through PRA
4. the grass productivity under the baseline conditions, in the control plot without fencing and protection is 1.3-2 dry t/ha in the three land categories (Table C.4.1)



**PROJECT DESIGN DOCUMENT FORM  
FOR AFFORESTATION AND REFORESTATION PROJECT ACTIVITIES (CDM-AR-PDD) - Version 05**

5. Grass productivity after fencing and protection under A/R activity is projected to increase by almost 100% according to a monitoring and evaluation report of the Integrated Watershed Development Project (Hills)-II in Himachal Pradesh<sup>21</sup> (Table D.1.2)

**Table D.1.2:** Change in grass or fodder availability with implementation of A/R project (based on field studies)

<b>Grass availability</b>	<b>Total quantity in tonnes</b>
Baseline (in the absence of project)	6,932
Post A/R project implementation	13,640
<b><i>Percent increase as a result of A/R project</i></b>	<b>96.76%</b>

- Under the proposed A/R CDM project, total grass available from the project area will be higher than under the baseline conditions (nearly double)
- According to the AR-ACM0001 methodology, if the planned AR-CDM project activity produces more grass or fodder than the baseline activity, leakage due to conversion of land for grazing need not be accounted.

**Table D.1.3:** Livestock population trends in Himachal Pradesh

<b>Livestock type</b>	<b>Livestock census</b>			
	<b>1987</b>	<b>1992</b>	<b>1997</b>	<b>2003</b>
Cattle (Cows & Bulls)	2244815	2165034	2001826	2196538
Buffaloes	794991	703549	652373	773229
Sheep	1112768	1078940	908831	906027
Goats	1120139	1118094	946529	1115587
<b>Total</b>	<b>5272713</b>	<b>5065617</b>	<b>4509559</b>	<b>4991381</b>

- The degraded forestlands are located at the higher elevation. Field measurements of grass productivity in the degraded forestland show that it is low at less than 2 dry t/ha/year (Refer to Table C.4.1). The degraded forestlands which are at a higher elevation and away from the settlement are not subjected to grazing compared to cropland and community land. Finally, the degraded forestland account for 80% of the total project area.
- According to the household survey, there is a shift from rearing traditional breeds of milch animals to high-yielding cross-bred cows. Cross-bred cows are normally stall-fed. It is shown above that grass productivity is projected to increase leading to increased grass and fodder availability for harvest and stall-feeding.
  - Further, the population of sheep and goats have declined in Himachal Pradesh, which indicates reduced grazing pressure (Table D.1.3)
  - Grass harvesting and stall feeding practice is on the increase in the state, which further shows that there will be no shift of grazing pressure since more grass will be available post-project implementation, which may ultimately lead to reduction in the practice of grazing
  - The Watershed Project has initiated activities to enhance fodder supply and improve the breed of cattle. There is a dedicated budget of about US\$ 5 million to promote stall-feeding under the larger Watershed project.

<sup>21</sup> IWDP, Kandi final reports

**Table D.1.4:** Estimates of leakage (tCO<sub>2</sub>-e)

Year	Shifting of activity	Total	Estimated Cumulative GHG Emissions tCO <sub>2</sub> -e
	Grazing		
2006			
2007			
2008			
2009			
2010			
2011			
2012			
2013			
2014			
2015			
2016			
2017			
2018			
2019			
2020			
2021			
2022			
2023			
2024			
2025			
<b>Total</b>			

## **SECTION E. Monitoring plan**

### **E.1. Monitoring of the project implementation:**

&gt;&gt;

#### **E.1.1. Monitoring of forest establishment and management if required for the compliance with the applicability conditions of the selected approved methodology:**

&gt;&gt;

Planting is phased over six years, starting in 2006. Monitoring of forest establishment and management is done to ensure that the planting quality conforms to the technology and practices described in A/R CDM PDD. Monitoring will be conducted during the initial three years and activities include:

*E. 1.2.1 Area planted: A record of the area planted under different strata over the years will be maintained to ensure consistency with the PDD (Table 4.1d in Annex 4)*

*E. 1.2.2 Species planted: A check of species planted in the different strata is conducted to ensure the species planting on different strata is in conformity with what is outlined in the PDD (Table 4.1c in Annex 4)*



**PROJECT DESIGN DOCUMENT FORM  
FOR AFFORESTATION AND REFORESTATION PROJECT ACTIVITIES (CDM-AR-PDD) - Version 05**

*E.1.2.3 Survival of seedlings:* The survival rate of seedlings is accounted for and annual monitoring of survival of seedlings is conducted by the monitoring team and seedlings replanted if the survival rates are very low (*Table 4.1b in Annex 4*)

<b>ID number<sup>22</sup></b>	<b>Data variable</b>	<b>Data unit</b>	<b>Measured (m), calculated (c) estimated (e) or default (d)<sup>23</sup></b>	<b>Recording frequency</b>	<b>Number of data points / Other measure of number of collected data.</b>	<b>Comment</b>
E.1.2.1	Area planted	Ha	M	annual		
E.1.2.2	Species planted	Number	M	Annual	Number of trees planted per species in a stratum	
E.1.2.3	Survival of seedlings	%	M	Annual	% survival	

**E.1.2. Information on how geographic coordinates of the project boundary are established, recorded and archived:**

>>

The geographic coordinates of the project boundary (and stratification inside the boundary) have been established, recorded and archived. Physically the boundaries have been delineated with fence posts or other important land marks (*Table 4.1.a in Annex 4*).

**E.1.3. If required by the selected approved methodology, describe, or provide reference to, SOPs and quality control (QC) and quality assurance (QA) procedures undertaken for data monitored, if not included in the relevant sections below:**

>>

Standard Operating Procedures (SOPs) will be developed for all field related activities. These SOPs would be adhered to at all times and all activities will be documented in detail for verification purposes as well as comparison of estimates over time. To ensure the collection of reliable field data; the following would be done:

- Training of field-team members so they are aware of all procedures and the importance of collecting data as accurately as possible
- Installation of test plots in the field to measure all pertinent components using the SOPs
- Checking of field measurements by a qualified person so as to correct any errors in techniques
- Documentation of all activities with a list of all members involved in field related activities and certification by the project leader that the team is trained
- Training of new staff recruited.

<sup>22</sup> Please provide ID number for cross-referencing in the PDD.

<sup>23</sup> Please provide full reference to data source.





**PROJECT DESIGN DOCUMENT FORM  
FOR AFFORESTATION AND REFORESTATION PROJECT ACTIVITIES (CDM-AR-PDD) - Version 05**

The QA/QC procedures for the critical data or parameters, along with uncertainty estimate are presented in the following table.

<b>Data (Indicate ID number )</b>	<b>Uncertainty level of data (High /Medium/Low)</b>	<b>Explain QA/QC procedures planned for these data, or why such procedures are not necessary.</b>
E.1.3.1 Area of stratum (i)	Low	Random verification of area planted per stratum
E.1.3.2 Total area of all sample plots in stratum (i)	Low	Random verification of area planted using remote sensing data
E.1.3.3 Diameter at breast height (DBH)	Low	Considering the large number of measurements taken, the measurement error is likely to be small. The random re-measurements are used to verify the prior measurements.
E.1.3.4 Height of tree	Low	Measurement, data collection and recording procedures are subject to random re-measurements and verification.

**E.2. Sampling design and stratification:**

>>

The methodology procedures for monitoring strata and defining the sampling framework are outlined below for living biomass and soil carbon.

*a) Stratification and sampling for ex-post calculations*

**i. Living biomass**

To increase the accuracy and precision of measuring and monitoring in a cost-effective manner, stratification of the project area into relatively homogeneous units is done considering the key factors influencing carbon stocks in the above and belowground biomass carbon pools using data sources such as archives, records, statistics, study reports and publications of national, regional or local governments, institutes and/or agencies, and published literature. Current land use, tenure and the location of the land categories were factors identified as critical and influencing the AGB and BGB carbon pools based on field observations and survey of records. Thus, three land categories of the baseline strata form the basis for stratification under pre-existing conditions.

- degraded forest land
- degraded community land
- degraded and abandoned private land

Stratification according to planned A/R CDM project activity involved adopting stand models suitable to the three broad land categories and altitudinal sub-strata for each land category (Refer to Section A.5.3).

The three altitude based sub-strata are as follows:

- High – 1400 to 1800 m
- Medium – 1100-1400 m



**PROJECT DESIGN DOCUMENT FORM  
FOR AFFORESTATION AND REFORESTATION PROJECT ACTIVITIES (CDM-AR-PDD) - Version 05**

- Low – 600-1100 m

The following three stage final ex-ante stratification is adopted based on a combination of pre-existing conditions, reforestation model and altitudinal sub-strata (Figure C.4.1).

- **Restoration forestry**; high, medium and low strata
- **Community forestry**; high, medium and low strata
- **Farm forestry**; high, medium and low strata

### **b) Sampling**

- **Living biomass**

Permanent sample plots will be used for sampling over time to measure and monitor changes in carbon stocks of above- and below ground biomass. Permanent sample plots are statistically efficient and address the covariance between observations at successive sampling events. Plots will be treated in the same way as other land within the project boundary, e.g., during site and soil preparation, planting, weeding, , thinning, etc., therefore, differential treatment of sample plots and other land parcels will not be practiced. The staff involved in management activities will not be informed of the location of monitoring plots.

#### **(i) Determining sample size**

The number of plots depends on species variation, accuracy and monitoring interval. In this methodology the total sum of samples (n) will be estimated as per a criterion of Neyman of fixed levels of accuracy and costs, according to Wenger (1984) and given in the approved methodology in the tool for “Calculation of the number of sample plots for measurements within A/R CDM project Activities, Version 02<sup>24</sup>”.

$$n = \left( \frac{t}{E} \right)^2 \left( \sum_{h=1}^L W_h S_h \sqrt{C_h} \right) \left( \sum_{h=1}^L W_h S_h / \sqrt{C_h} \right)$$

$$n_h = n \cdot \frac{W_h \cdot S_h / \sqrt{C_h}}{\sum_{h=1}^L W_h S_h / \sqrt{C_h}}$$

**Where:**

- L total number of strata
- t t value for a confidence level (95%)
- E allowable error ( $\pm 10\%$  of the mean)
- s<sub>h</sub> standard deviation of stratum h

<sup>24</sup>[http://cdm.unfccc.int/EB/046/eb46\\_repan19.pdf](http://cdm.unfccc.int/EB/046/eb46_repan19.pdf)



**PROJECT DESIGN DOCUMENT FORM  
FOR AFFORESTATION AND REFORESTATION PROJECT ACTIVITIES (CDM-AR-PDD) - Version 05**

$n_h$  number of samples per stratum that is allocated proportional to

$$W_h \cdot S_h / \sqrt{C_h}$$

$$W_h = N_h/N$$

$N$  number of total sample units (all stratum),  $N = \sum N_h$

$N_h$  number of sample units for stratum  $h$ , calculated by dividing the area of stratum  $h$  by area of each plot

$C_h$  cost to select a plot of the stratum  $h$

The allowable error on per-plot basis ( $\pm 10\%$ ) of the expected mean biomass carbon stock per plot in living trees at the end of a rotation, which will be estimated as part of the ex-ante estimation of the actual net GHG removals by sinks described in the baseline methodology. It is possible to reasonably modify the sample size after the first monitoring event based on the actual variation of the carbon stock changes determined from taking the  $n$  samples.

The sample size was calculated using a sampling calculator. The standard deviation used for calculating the sample size was derived using the following procedure.

- For each land category, a dominant forest type of the region with the dominant species was selected
  - o Forest land - *Pinus spp.* (forests of Himachal are dominated by Pines in the mid-Himalayan region)
  - o Community land – *Pinus spp.*
  - o Private land – *Syzigium cuminii*
- Literature was reviewed to obtain MAI for the dominant species for the selected forest type
- Standard deviation value was calculated for the MAI values of each forest type
- This standard deviation value derived for each of the forest type is used in estimating the sample size for forest land, community land and private land.

The total number of sample plots to be selected for monitoring for each stratum is given in Table E.2.1. This was estimated using the formula given above. The total number of sample plots to be selected for monitoring is 168.

**Table E.2.1.** Number of sample plots for each stratum for monitoring

Land category	Reforestation model	Altitudinal strata	Area (ha)	Standard deviation	Number of sample points
Degraded forestland	Restoration	High	1230.9	42.69	45
		Medium	969.7	42.69	35
		Low	976.2	42.69	35
Degraded community land	Community forestry	High	100.8	132.43	11
		Medium	66.9	132.43	8
		Low	125.3	132.43	14
Degraded and abandoned private land	Farm forestry	High	79.7	43.84	3
		Medium	221.4	43.84	8
		Low	232.1	43.84	9



**PROJECT DESIGN DOCUMENT FORM  
FOR AFFORESTATION AND REFORESTATION PROJECT ACTIVITIES (CDM-AR-PDD) - Version 05**

*(ii) Randomly locating sampling plots*

To avoid subjective choice of plot locations, plot reference points, the permanent sample plots will be located systematically with a random start, which is considered good practice in GPG-LULUCF. This will be accomplished with the help of a GPS in the field. The geographical position (GPS coordinates), administrative location, stratum and sub-stratum series number of each plots will be recorded and archived. It will be ensured that the sampling plots are distributed evenly over the project strata.

The aboveground biomass sampling requires a monitoring framework. The permanent sample plots will be used for aboveground biomass monitoring. Each plot will have its coordinates recorded using a GPS. The plot corners of rectangular plots will be located and the GPS coordinates noted. Plot markers will not be prominently displayed to ensure that permanent plots do not receive differential treatment from forestry personnel.

*(iii) Size of the plots*

The size of plots will depend on the density of trees and variation in the vegetation. Since the species mix and density are nearly uniform for reforestation and community forestry models, accounting for 87% of the total area, the sample plot size to be adopted is 25x20 m.

*(iv) Monitoring frequency*

The monitoring frequency is determined based on the IPCC Good Practice Guidance (GPG, 2003) and it varies for different pools.

- Aboveground biomass; Once in 5 years

The first monitoring will be conducted during 2010 for the area planted during 2006-07, which is the fifth year after first planting.

Conditions for update of strata

The sampling strata may not be merged and the sample size estimated in Tables E.2.1 and E.2.2 will be implemented in the field. However, in a scenario of nearly identical mean annual increment of biomass as well as the survival rates of trees, some of the strata may be merged for monitoring. Thus the merging of sampling strata will be determined by the mean biomass increment values as well as survival rates.

**E.3. Monitoring of the baseline net GHG removals by sinks, if required by the selected approved methodology:**

>>

The baseline carbon stock changes need not be monitored on implementation of the project, because the accepted baseline approach 22(a) assumes continuation of existing changes in carbon pools within the project boundary from the time of validation. Further, as per the AR-ACM0001/Version 03 methodology, monitoring of baseline net GHG removals by sinks is not required.

Data and parameters that are monitored: NONE

>>



**PROJECT DESIGN DOCUMENT FORM  
FOR AFFORESTATION AND REFORESTATION PROJECT ACTIVITIES (CDM-AR-PDD) - Version 05**

**E.4. Monitoring of the actual net GHG removals by sinks:**

>>

The actual net greenhouse gas removals by sinks represent the sum of the verifiable changes in carbon stocks in the carbon pools within the project boundary, minus the increase in GHG emissions measured in CO<sub>2</sub> equivalents by the sources as a result of the implementation of an AR CDM project activity. The calculations will be performed as per the periodicity outlined in the monitoring plan.

Monitoring methods adopted for collecting data to calculate the GHG removals and emissions follow the guidance of the methodology AR-ACM0001. The monitoring methods aim to ensure that the management practices are implemented in accordance with the PDD. The monitoring plan of the A/R CDM project activity covers the following elements:

1. Monitoring of the project boundary
2. Monitoring of forest establishment and management
3. Sampling design and stratification with sampling framework

The details of monitoring for assessing forest establishment and management practices are presented in this section.

The activities to be monitored for monitoring of forest establishment were described in Section E.1.1. The parameters to be monitored are as follows and the template and the format for recording the data is provided in the Monitoring Plan (Annex 4).

- i. Geographical location of plots – refer to Table 4.1a – Monitoring Plan (Annex 4)
- ii. Species planted and survival in different stand models refer to Table 4.1b – Monitoring Plan (Annex 4)
- iii. Species composition refer to Table 4.1c – Monitoring Plan (Annex 4)
- iv. Total area of all sample plots refer to Table 4.1d – Monitoring Plan (Annex 4)
- v. DBH and height measurements refer to Table 4.1e – Monitoring Plan (Annex 4)
- vi. Status of contractual agreements refer to Table 4.1f – Monitoring Plan (Annex 4)

The *ex ante* calculation of net anthropogenic GHG removals by sinks during the crediting period shall be based on measured or existing published data.

**Data and parameters available at validation:**

<b>Data / Parameter:</b>	$I_{v,i,t}$
Description/unit:	Average annual increment of species <i>j</i> in stratum <i>i</i> for year <i>t</i> / t.d.m ha <sup>-1</sup> yr <sup>-1</sup>
Value applied:	as per Table D5 in section D.1
Source of data:	Local forest inventory; official records; published reports
Justification of choice / Measurement procedures (if any):	To ensure conservativeness in the <i>ex ante</i> estimation, annual increment value immediately lower than the mean value published for the age class of the stand model was selected.
Any comment:	



**PROJECT DESIGN DOCUMENT FORM  
FOR AFFORESTATION AND REFORESTATION PROJECT ACTIVITIES (CDM-AR-PDD) - Version 05**

<b>Data / Parameter:</b>	BEF <sub>2,j</sub>
Description/unit:	Biomass expansion factor for conversion of stem biomass to above-ground tree biomass for tree species <i>j</i> / Dimensionless
Value applied:	See Values in attached excel file [ <i>HP Project_Growth and Expansion factor parameters with reference (Attachment 29).xls</i> ]
Source of data:	See References in attached excel file [ <i>HP Project_Growth and Expansion factor parameters with reference (Attachment 29).xls</i> ]
Justification of choice / Measurement procedures (if any):	Published species-specific or group of species-specific BEF values are applied. The BEF values of closely related species or those with similar growth characteristics are used for species that do not have published values,
Any comment:	

<b>Data / Parameter:</b>	R <sub>i</sub>
Description/unit:	Root-shoot ratio for tree species or group of species <i>j</i> / kg d.m.yr <sup>-1</sup> (kg d.m.yr <sup>-1</sup> ) <sup>-1</sup>
Value applied:	See Values in attached excel file [ <i>HP Project_Growth and Expansion factor parameters with reference (Attachment 29).xls</i> ]
Source of data:	See references in attached excel file [ <i>HP Project_Growth and Expansion factor parameters with reference (Attachment 29).xls</i> ]
Justification of choice / Measurement procedures (if any):	Published species-specific or group of species-specific root-shoot ratio values are applied. The root-shoot ratio values of closely related species or those with similar growth characteristics are used for species that do not have published values,
Any comment:	

<b>Data / Parameter:</b>	D <sub>i</sub>
Description/unit:	Basic wood density for species <i>j</i> / t d.m. m <sup>-3</sup>
Value applied:	See values in attached excel file [ <i>HP Project_Growth and Expansion factor parameters with reference (Attachment 29).xls</i> ]
Source of data:	See references in excel file [ <i>HP Project_Growth and Expansion factor parameters with reference (Attachment 29).xls</i> ]
Justification of choice / Measurement procedures (if any):	Published species-specific or group of species-specific wood density values are applied. The wood density values of closely related species or those with similar growth characteristics are applied for species that do not have published values,
Any comment:	



**PROJECT DESIGN DOCUMENT FORM  
FOR AFFORESTATION AND REFORESTATION PROJECT ACTIVITIES (CDM-AR-PDD) - Version 05**

<b>Data / Parameter:</b>	$CF_j$
Description/unit:	Carbon fraction of dry matter for species of type $j$ / t C t <sup>-1</sup> d.m.
Value applied:	0.5
Source of data:	IPCC (2003) GPG LULUCF
Justification of choice / Measurement procedures (if any):	Default value
Any comment:	

<b>Data / Parameter:</b>	$\Delta C$
Description/unit:	Default annual increase in carbon stock in soil organic carbon; t C ha <sup>-1</sup> yr <sup>-1</sup>
Value applied:	0.5
Source of data:	Per methodology AR ACM0001
Justification of choice / Measurement procedures (if any):	Default value
Any comment:	

<b>Data / Parameter:</b>	$t_{\text{equilibrium}}$
Description/unit:	Time until a new equilibrium in carbon stock in soil organic matter is reached in area of land $i$ ; years
Value applied:	20
Source of data:	Per methodology AR ACM0001
Justification of choice / Measurement procedures (if any):	Default value
Any comment:	

**Data and parameters that are monitored:**

The following parameters will be monitored during the project activity.

<b>Data / Parameter:</b>	$A_i$
Description/unit:	Area of stratum $i$ / ha
Source of data:	Measured
Measurement procedures:	Use of surveys /GPS and GIS for monitoring of strata
Monitoring frequency:	Monitoring period
QA/QC procedures:	
Any comment:	



**PROJECT DESIGN DOCUMENT FORM  
FOR AFFORESTATION AND REFORESTATION PROJECT ACTIVITIES (CDM-AR-PDD) - Version 05**

<b>Data / Parameter:</b>	$A_{sp,i}$
Description/unit:	Total area of all sample plots in stratum i / ha
Source of data:	Field measurement
Measurement procedures:	
Monitoring frequency:	Every 5 years subsequent to the first periodic verification
QA/QC procedures:	
Any comment:	

<b>Data / Parameter:</b>	DBH
Description/unit:	Diameter at breast height of trees / cm
Source of data:	Measurement on permanent sample plots
Measurement procedures:	Measurement of diameter of trees above minimum <i>DBH</i> defined on permanent sample plots following forest inventory procedures In the project.
Monitoring frequency:	Every 5 years subsequent to the first periodic verification
QA/QC procedures:	Diameter measurements are randomly checked during the monitoring period to ensure accuracy of measured data
Any comment:	

<b>Data / Parameter:</b>	$H_i$
Description/unit:	Tree height / meters
Source of data:	Measurement on permanent sample plots
Measurement procedures:	Measurement of height of trees on sample plots following forest inventory procedures
Monitoring frequency:	Every 5 years subsequent to the first periodic verification
QA/QC procedures:	Height measurements are randomly checked during monitoring period to ensure accuracy of measured data
Any comment:	

<b>Data / Parameter:</b>	$t_2, t_1$
Description/unit:	Years of the monitoring activity / years
Source of data:	Project monitoring period
Measurement procedures:	
Monitoring frequency:	Every 5 years subsequent to the first periodic verification
QA/QC procedures:	
Any comment:	

<b>Data / Parameter:</b>	$E_{BiomassBurn,t}$
Description/unit:	Non-CO <sub>2</sub> emissions due to biomass burn from natural fires during year <i>t</i> / t CO <sub>2</sub> -e
Source of data:	Project monitoring





**PROJECT DESIGN DOCUMENT FORM  
FOR AFFORESTATION AND REFORESTATION PROJECT ACTIVITIES (CDM-AR-PDD) - Version 05**

Measurement procedures:	The monitoring of emissions from natural fires is only required, if significant;
Monitoring frequency:	Annual
QA/QC procedures:	Fire management plan to be implemented and areas affected by natural fires if any are surveyed and reported.
Any comment:	

**E.5. Leakage:**

&gt;&gt;

Not applicable

**E.5.1. Proposed measures to be implemented to minimize potential leakage:**

&gt;&gt;

The potential sources of leakage relevant to the proposed A/R CDM project (based on AR-ACM0001, Version 03 methodology) include:

- Carbon stock decreases caused by displacement of pre-project activities;
  - o grazing

The leakage estimates made from the above source is less than 5% of the actual net GHG removals projected for the A/R CDM project and are therefore insignificant<sup>25</sup>. Thus, leakage estimates are not included in the estimation of net GHG removals by sinks. However, the A/R CDM project will undertake the following measures to minimize potential leakage from the above source.

***Carbon stock decreases caused by displacement of grazing***

- Fodder and grass production under the A/R CDM project is shown to lead to nearly doubling of the pre-project grass production<sup>26</sup>
- Local communities will be permitted to harvest and stall feed the livestock<sup>27</sup>
- Under the watershed development project, activities implemented to promote stall feeding to avoid grazing<sup>28</sup>

**E.5.2. Specify the procedures for the periodic review of implementation of activities and measures to minimize leakage, if required by the selected approved methodology:**

No monitoring of leakage is implemented as there is no leakage associate with the project.

**E.6. Provide any additional quality control (QC) and quality assurance (QA) procedures undertaken for data monitored not included in section E.1.3:**

<sup>25</sup> [http://cdm.unfccc.int/EB/031/eb31\\_repan16.pdf](http://cdm.unfccc.int/EB/031/eb31_repan16.pdf)

<sup>26</sup> IWDP, Kandi final reports

<sup>27</sup> PIP – MHWDP document

<sup>28</sup> PAD/PIP MHWDP document



PROJECT DESIGN DOCUMENT FORM  
FOR AFFORESTATION AND REFORESTATION PROJECT ACTIVITIES (CDM-AR-PDD) - Version 05

>>  
Not Applicable

Data (Indicate ID number)	Uncertainty level of data (High/Medium/Low)	Explain QA/QC procedures planned for these data, or why such procedures are not necessary

**E.7. Please describe the operational and management structure(s) that the project proponents will implement in order to monitor actual net GHG removals by sinks and any leakage generated by the proposed A/R CDM project activity:**

>>  
The project will be implemented and managed by the MHWDP till 2013, and subsequently the State Forest Department will manage the project. The MHWDP project directorate will coordinate all the monitoring activities. The institutional arrangements for monitoring of the GHG removals by sinks and leakage are presented in Figure E.7.1. The project directorate will prepare the monitoring plan and delegate responsibility to different institutions and coordinate the monitoring exercise

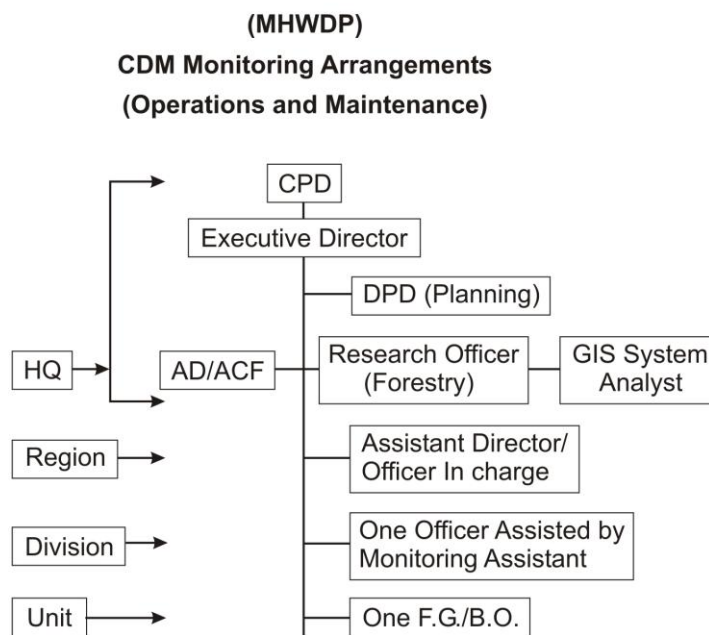

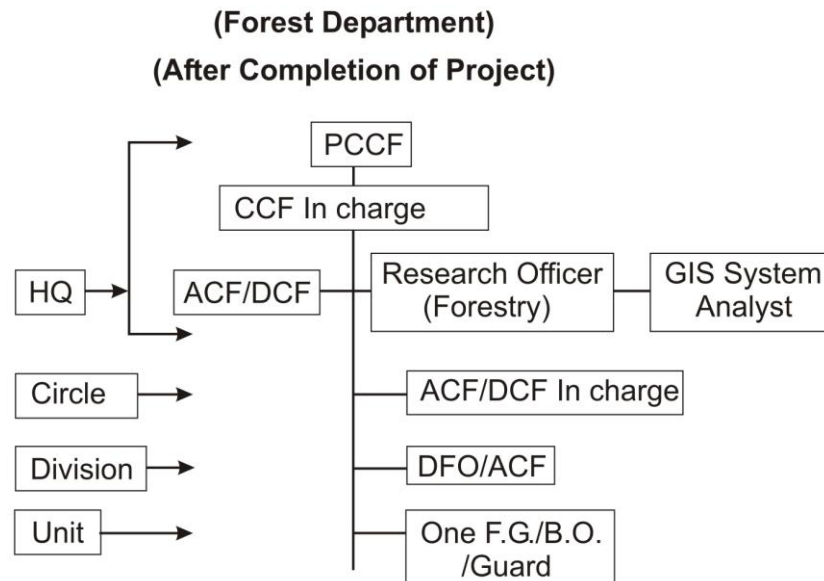

**Figure E.7.1:** Institutional framework for monitoring

Name of persons applying the monitoring plan:

1. MHWDP: Chief Project Director, Mid Himalayan Watershed Development Project, Solan & Executive Director, CDM Bio-Carbon Project, MHWDP, Solan (H.P) - INDIA
2. Forest Department- Principal Chief Conservator of Forests, Forest Hq. Talland, Shimla (H.P) - INDIA

## SECTION F. Environmental impacts of the proposed A/R CDM project activity

### F.1. Documentation on the analysis of the environmental impacts, including impacts on biodiversity and natural ecosystems, and impacts outside the project boundary of the proposed A/R CDM project activity:

>>

The project aims at protecting the watersheds, enhancing tree cover, conserving biodiversity and promoting livelihood in addition to enhancing carbon sinks in 4003.07 ha of degraded sloping hilly areas of mid-Himalayan region. Some of the potential environmental benefits are presented in this section.

**Overview of Environmental Analysis:** The PDD outlines a detailed environmental analysis and mitigation measures. The PDD itself is an outcome of the detailed environmental analysis undertaken in 42 GPs (as the sample size - out of 177 project GPs). Necessary technical specifications including a detailed monitoring mechanism are mentioned in this PDD. It also describes an institutional accountability required during the implementation process.

The CDM Project is proposed as an additional component of the Mid-Himalayan Watershed Development Project (MHWDP). The focus of the projects is different and implemented on different lands – at the same time complement each other in all respects. The MHWDP focuses on soil and moisture conservation in arable agriculture land and in village common land through field bunding, terracing, check dams, gully plugging, development of grass-lands and providing support for high value agriculture production with forward and backward market linkage support. However, reforestation work



**PROJECT DESIGN DOCUMENT FORM  
FOR AFFORESTATION AND REFORESTATION PROJECT ACTIVITIES (CDM-AR-PDD) - Version 05**

did not become an integral part of MHWDP because villagers in MHWDP areas neither received any cash incentive for reforestation work nor timber rights. Whereas in CDM project, the focus is only on reforestation for which the farmers will receive cash incentive (by being a potential seller of carbon credit) on three types of lands; (i) non-arable agriculture wasteland referred to as abandoned farm land, (ii) degraded forestland, and (iii) degraded common property land. In brief, MHWDP supports soil and moisture conservation work and grassland development, and the CDM project intends to support reforestation programme. The CDM project can be perceived as an environmental mitigation project for the ongoing land degradation and loss of forest problem in HP.

The project will follow the Environmental Social Guidelines (ESG) and Environmental Social Management Framework (ESMF) already developed as safeguard measures under the MHWDP.

### 1. Within the Project area:

#### Carbon revenue as an incentive for watershed protection

The watersheds, particularly the catchment areas of watersheds, in the hilly terrain of Himachal Pradesh are highly vulnerable to land degradation, soil erosion and excessive water runoff. The state has been implementing a number of watershed development programmes with budgetary support. Watershed projects with activities such as soil and water conservation and re-vegetation measures provide long-term benefits to the farmers and the community. There is need for incentives to village communities and farmers to protect and regenerate watersheds.

The proposed A/R CDM project activity aims to provide financial incentives to farmers and communities in the form of CDM revenue from the sale of CERs to motivate them to protect and regenerate the catchments of the watersheds (Table F.1.1). The potential revenue from the sale of CERs is given in Table F.1.1.

**Table F.1.1:** Revenue from sale of CERs

	<b>CERs (tCO<sub>2</sub>-e)</b>	<b>CERs/year (tCO<sub>2</sub>-e)</b>	<b>CER revenue (Rs./year) at US\$ 4/tCO<sub>2</sub></b>	<b>CER revenue (Rs./year) at US\$ 10/tCO<sub>2</sub></b>
Total for the whole project area	8,28,016	41,979	6,624,127	16,560,318
Average per hectare	207	10.34	1,655	4,137

The financial incentive from the sale of CERs could provide a very critical incentive to the stakeholders to protect, regenerate and manage the watersheds. This is particularly important to the state, which is a catchment for major rivers of north India such as Ravi and Beas. This project demonstrates the role of forest carbon sinks to conserve, protect and to regenerate watersheds and highlights the synergy between global environmental benefits and local environmental benefits (e.g., watershed protection).

#### Biodiversity

The plant biodiversity index of the baseline scenario is low as shown below:



**PROJECT DESIGN DOCUMENT FORM  
FOR AFFORESTATION AND REFORESTATION PROJECT ACTIVITIES (CDM-AR-PDD) - Version 05**

- Degraded forestland – 1.16
- Degraded community land – 1.22
- Degraded and abandoned private land – 1.11

A/R activity will involve planting of native tree species on degraded land largely from indigenous gene pool. About 1000 trees comprising 10 to 20 tree species will be planted per hectare. Therefore, A/R would have positive impacts on the vegetation and biodiversity. The biodiversity of flora and fauna will be promoted due to planting of native species, protection and promotion of natural regeneration. Apart from planting, largely indigenous tree species, 4003.07 ha will be brought under protection from unregulated grazing, fire and fuelwood collection, leading to natural regeneration of large number of native tree, shrub and herb species.

### **Suppression of invasive alien species**

The unregulated grazing and fire have contributed to the spread of invasive species such as Lantana, Parthenium and Eupatorium (Table F.1.2). Protection and management (controlled grass harvesting practices) will suppress the germination and growth of invasive alien species. It is also proposed to eliminate invasive plants through weeding and other management practices.

**Table F.1.2:** Dominant invasive alien species found in the degraded lands of Himachal Pradesh

<b>Invasive species</b>	<b>Tree/Herb/Shrub</b>
<i>Lantana camara</i>	Shrub
<i>Parthenium</i> sp.	Shrub
<i>Eupatorium odoratum</i>	Shrub

### **Hydrology and watershed protection**

The entire project is located in the Mid-Himalayan watershed area. The rate of soil erosion from these steep slopes is estimated to be 50 t/ha of soil annually. Thus, soil erosion will be reduced by 70-80 % with A/R activities. A number of streams and rivers originate in the area and feed major northern Indian rivers. These streams and springs are likely to increase their discharge rate with the intervention under the A/R activities. While in a short span of time it may not show these positive impacts, but in long run, A/R activities will help in source sustainability of these springs and streams.

A/R activity would enable protection and improvement of soil on these lands and facilitate rainwater percolation. Tree cover increases soil moisture. Hence, it would enhance the productivity of these lands along with recharging of ground water.

### **Biomass flow**

Planting and protection will lead to growth and regeneration of multiple plant forms (trees, grass, shrubs, etc), leading to increase in biomass supply to the community. This will include supply of fuelwood, grass, medicinal plants, gum, seeds etc., as a result of the A/R CDM project. For example, grass productivity under protection is likely to be nearly double (Table D.1.2).

### **NTFPs (Non-Timber Forest Products)**

**PROJECT DESIGN DOCUMENT FORM  
FOR AFFORESTATION AND REFORESTATION PROJECT ACTIVITIES (CDM-AR-PDD) - Version 05**

People collect resin from *Pinus roxburghii*, fruits from *Emblica officinalis*, seeds from *Terminalia chebula*, *Acacia catechu* etc. These trees are almost absent on land proposed for A/R CDM activities. Reforestation models developed for planting under the project include a combination of many species of trees that yield non-timber forest produce. Thus, A/R activity would increase the availability of NTFPs (Table F.1.3). In addition, local community could generate additional income by processing the NTFPs and marketing them. This would provide an opportunity for setting up of NTFP processing industry, creating employment and generating income through value addition at the local level.

**Table F.1.3:** Commercial and subsistence NTFPs from A/R CDM reforestation models

Reforestation model	Tree species	NTFPs for subsistence use	Commercial NTFPs for processing
Restoration model	<i>Alnus nitida, Salix alba, Populus ciliata, Ailanthus excelsa, Toona ciliata, Robinia pseudoacacia, Juglans regia, Aesculus indica, Prunus armenica, Cedrus deodara, Quercus leucotrichophpra, Pinus wallichiana, Melia azadirachta, Grevellia robusta, Bombax ceiba, Dendrocalamus strictus, Pinus roxburghii, Bauhinia variegata, Sapindus mukorossi, Syzygium cumini, Mangifera indica, Aegle marmelos, Artocarpus lakoocha s, Hicoria carya, Morus alba, Tectona grandis, Grewia optiva, Acacia catechu, Dalbergia sissoo, Emblica officinalis, Terminalia arjuna, Pongamia pinnata, Azadirachta indica, Olea glandulifera, Acacia nilotica, Albizzia procera, Albizzia lebbeck, Terminalia chebula, Terminalia bellerica, Terminalia alata, Butea monosperma</i>	<i>Sapindus mukorossi, Mangifera indica, Aegle marmelos, Syzygium cumini, Artocarpus lakoocha, Prunus arménica, Juglans regia, Hicoria carya, Emblica officinalis, Dendrocalamus strictus</i>	<i>Acacia catechu, Emblica officinalis, Azadirachta indica, Terminalia bellerica, Terminalia arjuna, Terminalia chebula, Juglans regia, Hicoria carya, Pongamia pinnata, Dendrocalamus strictus</i>
Community forestry model			
Farm forestry model			

**Grass production**

Average grass production of lands in the baseline ranged from to 1.3 to 2 tonnes per ha/year. An increase in grass production by almost 100% (Refer to Table D.1.2) is observed when grazing land is protected (Monitoring and evaluation report of the Integrated Watershed Development Project (Hills)-II in Himachal Pradesh). CDM plantations would be protected from fire and grazing, facilitating an increase in grass production. Local communities will be permitted to harvest grass periodically from the plantations, thus enhancing the availability of grass from the project area. This increased grass availability would improve the health of livestock and milk production.

**Soil fertility**

Land selected for CDM A/R plantation support poor soils due to erosion and lack of organic matter. Soil organic carbon in these soils range from 27 to 30 tC/ha whereas in the forests the mean stock was 123.79



**PROJECT DESIGN DOCUMENT FORM  
FOR AFFORESTATION AND REFORESTATION PROJECT ACTIVITIES (CDM-AR-PDD) - Version 05**

tC/ha (Table C.2.2). CDM plantations would arrest soil erosion and add organic matter to soils during the project period. This would increase soil organic matter of the project area.

#### **Reduction of vulnerability of mountain forest ecosystem**

According to the reports of IPCC (Working Group II) the forest ecosystems and the hilly mountainous ecosystems are highly vulnerable to climate change. A study (Ravindranath et al. 2006) on impact of climate change and forest ecosystems in India has shown that most the forested grids of Himachal Pradesh are highly vulnerable to climate change and are projected to experience change in forest types, before the end of the current century.

A/R activity which includes planting of multiple species would reduce the vulnerability since different species have different temperature tolerance. Thus, the mountain forest ecosystems including degraded forests will be less vulnerable to impacts of climate change.

#### **Reduction of the threat of pest attack**

Monoculture plantations are known to be more vulnerable to pests and diseases. Plantations included in the A/R CDM project have multi-species, which reduces the threats of major pest attacks. The risk of pest infestation is also likely to be insignificant in the project considering the field observation of the plantations implemented in the previous decades.

#### **Carbon sink enhancement**

Carbon sink enhancement in degraded forest, community and private land due to A/R project activities in 4003.07 ha will lead to net removal of 8,28,016 tCO<sub>2</sub>-e during the project period of 20 years. This will contribute to addressing the climate change problem through removal of CO<sub>2</sub> from the atmosphere and storing it in vegetation and oils.

## **2. Benefits outside the project area**

#### **Reduced pressure on forests**

- The rural communities in the project area collect a large percent of their fuelwood requirement for cooking from the nearby forests and plantations. They collect it largely from forests and plantations nearest to their GP, outside the project boundary. The project area covers a population of 4,35,918. Even assuming an average of 1 to 2 tonne of fuelwood in the form of woody litter and dried branches, the total fuelwood supplied from the project area will be about 10,000 to 20,000 tonnes per year, on a sustainable basis.
- Thus, sustainable and additional fuelwood supply from CDM plantations, in the form of woody litter and deadwood will reduce the pressure on the natural forests that are outside the project area. This will have a positive impact on conservation of forests outside the project area.

#### **Reduced flooding**

- Lower elevation areas of Himachal Pradesh and neighboring states of Punjab, Haryana experience floods during monsoon from rivers flowing from higher regions of Himachal Pradesh. CDM plantations in the hilly catchment of rivers such as Ravi and Beas and their tributaries will



**PROJECT DESIGN DOCUMENT FORM  
FOR AFFORESTATION AND REFORESTATION PROJECT ACTIVITIES (CDM-AR-PDD) - Version 05**

enhance the harvest and percolation of rainwater in the plantation area. This will reduce the surface runoff of rainwater that normally causes floods.

**Demonstration effect of watershed protection and carbon revenue incentives**

- Large-scale implementation A/R CDM project activities, covering 4003.07 ha and the flow of CER revenues and other benefits such as increased grass and fuelwood supply, enhanced NTFP availability will have a demonstration effect on the neighboring villages and GPs.
- The neighboring GPs and farmers may also wish to undertake reforestation activities for the protection of watershed as well as creation of carbon sinks.

**Reduce landslides**

- Occurrence of landslides is a common phenomenon in the hilly regions of Himachal Pradesh during the rainy season. The state has about 2.4 million hectare of wasteland without any vegetation cover. Furthermore, about 0.53 million hectare are open forests. These lands are vulnerable to landslides.
- CDM A/R plantations on degraded land will stabilise these lands and help to reduce their susceptibility to landslides, outside the project boundary.

**3. Project risks and proposed mitigation measures**

○ **Fire**

- **Risks:** Incidence of fire in forests and grasslands is reported in selected pockets of the Himachal Pradesh. At the same time reported case of fire in proposed project areas (degraded land) is insignificant. However, there could be a possibility of fire spreading to the A/R CDM project area.
- **Mitigation:** Regeneration of degraded land in multiple discrete parcels with multiple species is likely to make these lands less vulnerable to fires. GP level user groups would be involved in managing the project plantations. An effective watch and ward especially during the summer would prevent the fire accidents. Large-scale fire is unlikely in the project area. The institutional arrangements, improved management and distribution of carbon revenues to the local communities would limit the fire risk.

○ **Grazing**

- **Risks:** Livestock graze in forest, community and private land. There is a risk of grazing by these animals in the CDM plantation areas and thereby damaging the planted or regenerated seedlings.
- **Mitigation:** The risk of grazing to planted areas would be avoided or minimized due to the following:
  - CDM plantation will be protected by physical measures like fencing.
  - Stall feeding is being promoted under the MHWDP project in the same area
  - Increased grass production from the project plantations is likely to encourage more livestock owning households to shift to grass harvesting and stall feeding.
  - Formation of participatory institutions for protection and management of CDM project plantations will stop the practice of livestock grazing and promote stall feeding.
  - Reduction in livestock population and shift to improved breeds that require stall feeding will reduce the grazing demand, and this is being promoted under the watershed project.





**PROJECT DESIGN DOCUMENT FORM  
FOR AFFORESTATION AND REFORESTATION PROJECT ACTIVITIES (CDM-AR-PDD) - Version 05**

- **Invasive species**
  - **Risks:** Invasive species spread widely because of their ability to disperse and establish aggressively in new areas.
  - **Mitigation:** Majority of the species selected for planting in the CDM plantations are indigenous or locally adapted species. The mix of species considered for the reforestation models do not include any profusely spreading exotic tree species. Large-scale colonisation by any invasive weed species is unlikely due to the silvicultural management.
  
- **Site preparation**
  - **Risks:** Raising of forest plantations involve operations such as digging pits for planting and filling the pits etc. There is a risk of disturbance to soils during these operations if machines are used that could lead to GHG emissions.
  - **Mitigation:** Site preparation for the plantations would not involve use of machines. Site preparation would be carried out using only manual labour. Site preparation and disturbance of top soil is restricted to less than 1% of the top soil surface area. Thus, there is no risk of GHG emissions due to soil preparation.
  
- **Low productivity of reforestation models**
  - **Risks:** Land selected for CDM plantations is eroded and have shallow soils. Soils are characterised by low fertility and low soil organic matter (about 25tC/ha). Moderate biomass growth rates are used in the calculation of the net GHG removals. There is a risk of low biomass productivity and carbon accumulation. Thus, there is a risk that the projected net carbon removals may not be achieved.
  - **Mitigation:** Package of practices for high yields will be followed in raising the plantations. High quality seed material will be obtained and healthy seedlings will be selected for planting. Adoption of good silvicultural package of practices, selection of high quality seed material and protection is likely to ensure the projected rates of growth of biomass and carbon accumulation.
  
- **Pest attack and use of pesticide**
  - **Risks:** There is a risk of pest attack on reforestation models raised under the A/R CDM project.

**Mitigation:** There is no evidence of any serious pest attack on the A/R programmes implemented in the state of Himachal Pradesh. There is no example of use of pesticides in any A/R programme. Furthermore, watershed project has a component for promoting integrated pest management systems in all the watershed divisions it is implemented. Thus there is minimal risk of pest infestation in the A/R CDM project

**F.2. If any negative impact is considered significant by the project participants or the host Party, a statement that project participants have undertaken an environmental impact assessment, in accordance with the procedures required by the host Party, including conclusions and all references to support documentation:**

>>

No significant negative impacts due to implementation of A/R CDM activity are projected. However, A/R activity could result in temporary loss of grazing land for the livestock.



**PROJECT DESIGN DOCUMENT FORM  
FOR AFFORESTATION AND REFORESTATION PROJECT ACTIVITIES (CDM-AR-PDD) - Version 05**

- **Temporary loss of grazing land:** Land selected for A/R activities under the project include degraded forest, community and private abandoned land. These lands are currently partially used for grazing. When these lands are brought under CDM project and protected from grazing, there would be a reduction in the area available for grazing in the project scenario. This issue was investigated and the results are as follows;
  - All the evidence available shows that grass production and availability of grass or fodder will increase in the project area, due to protection and management. Refer to Table D.1.2 for the data which shows that grass production nearly doubled with protection and management.
  - Harvesting grass and stall feeding is a common practice adopted in the GPs (as shown by the Household Survey). So shifting from grazing to grass harvest and stall feeding will not be a major change in their traditional practice.
  - The evidence on the livestock population trends shows that in Himachal Pradesh firstly, the livestock population is declining and secondly, that there is a shift from local breeds to improved breeds, which are stall-fed and not grazed.
  - Watershed project has a programme to promote stall feeding and improving the quality of breeds and these high yielding cross-breed cows are stall-fed and not grazed.

Thus all the evidence shows that there will be no negative impacts due to regulation of grazing and in fact there will be positive impacts on the ecology (soil conservation) and economics (such as improved milk production).

**F.3. Description of planned monitoring and remedial measures to address significant impacts referred to in section F.2. above:**

>>

Not applicable

**SECTION G. Socio-economic impacts of the proposed A/R CDM project activity**

**G.1. Documentation on the analysis of the major socio-economic impacts, including impacts outside the project boundary of the proposed A/R CDM project activity:**

>>

Agriculture is the main occupation and source of income to the rural communities in the project area. However, agricultural production is suffering for various reasons and the income is unpredictable and is becoming low in recent years (MHWDP). Implementation of CDM project activities is expected to provide multiple socio-economic benefits to the local communities. One of the main economic benefits is the flow of CER carbon revenues to GPs and individual families. Some of the potential socio-economic benefits are presented in this section.

**G.1.1. Within the project area**

*i) Flow of CDM CER revenues*

Implementation of A/R CDM project will generate CDM CERs. The CER revenue from degraded forest and community land will be shared with the GPs and in turn with the individual families. CER revenue from the degraded private land will be fully transferred to the respective farmers. The MHWDP will manage the fund flow initially till 2013 and Forest Dept will manage the fund flow later from CERs to the GPs and farmers, under a signed agreement involving all the stakeholders. The extent of CDM CER



**PROJECT DESIGN DOCUMENT FORM  
FOR AFFORESTATION AND REFORESTATION PROJECT ACTIVITIES (CDM-AR-PDD) - Version 05**

revenue is a conservative estimate at a carbon price of US\$ 4/tCO<sub>2</sub>. The flow of revenue per hectare is quite significant compared to the per capita income in rural Himachal Pradesh (Rs. 14,682/capita).

*ii) Changes in land use pattern and implications*

Under the A/R CDM project three reforestation stand models involving multiple tree species will be planted in degraded forest, community and private abandoned land, leading to changes in land use and land cover with the following potential economic benefits:

- Protection of watersheds leading to positive impacts in terms of soil and moisture conservation
- Increased fodder or grass supply to livestock leading to increase in milk production
- Supply of NTFPs from planted forests
- Increase in employment due to improved grass production
- Increase in household incomes from improved dairy breeds, stall feeding, NTFP production and improvements in crop production
- Some of these socio-economic impacts are presented in detail in the following sections

*iii) Increase in employment opportunity*

Employment generation is one of the objectives of all A/R projects and it results from the following activities under the A/R CDM project

- Establishment of forest plantations would involve activities such as nursery, land preparation, planting, silvicultural practices and protection. These activities would generate employment to local population. On an average 343 person days of employment are generated per hectare of reforestation. Additional employment generated from these activities is provided in Table A.2.1.
- Doubling of grass production will require labour for harvesting and stall feeding
- Planting of NTFP yielding species will lead to supply of multiple NTFPs, whose collection and processing will generate additional employment.
- Activities implemented to support agriculture production, watershed protection and soil and water conservation.

*iv) Women empowerment*

- CDM CER revenue will contribute to empowerment of women groups (such as Self Help Groups) and institutions
- It is proposed to form Carbon Management Committee or CDM User groups, where women will have a major role in managing the CDM revenue.
- GPs where women are significantly represented under the regulations will have a major role in all decisions related to A/R CDM project as well as sharing the CDM CER revenue.
- In the project area Self Help Groups are functioning and will continue to play a key role in protecting and managing the CDM A/R activities.
- Under the watershed programme several institutional arrangements and capacity building programmes are being planned to involve and empower women.

*v) NTFP availability and income generation*

- Currently the flow of NTFPs from land categories selected for the A/R activities is marginal or absent. The list of NTFP yielding species to be planted under the project will provide several NTFPs.



**PROJECT DESIGN DOCUMENT FORM  
FOR AFFORESTATION AND REFORESTATION PROJECT ACTIVITIES (CDM-AR-PDD) - Version 05**

- Many of the species included in the A/R activities yield commercially important NTFPs such as *Acacia catechu*, *Pinus roxburghii*, *Embllica officinalis* etc.
- Additional income is likely to be generated by processing and marketing of NTFPs such as amla, ritha, jamun, mango, pecanut, etc. (Table F.1.3)

**vi) Fuelwood supply**

Fuelwood is a major source of energy for cooking in the project area. Currently fuelwood is collected from several sources including natural forests, plantations and farms. Under the CDM project, the local communities will be permitted to collect dead and fallen twigs and branches from the pre-existing trees as well as the planted trees. Out of above ground biomass productivity of about 4-6 tonnes/ha/year expected from the project activities, about 1 to 2 t/ha/year of woody biomass could be considered as available as fuelwood for gathering by the local communities. Felling of green branches and stems will be banned by the GPs from the project areas. Further assured supply of fuelwood from CDM plantations will reduce the time taken for fuelwood collection and the associated drudgery, particularly for women.

**vii) Financial benefits to landless and the poor**

Agriculture is the main occupation and source of income for farmers. Landless or the poor depend on farm wages for their living. Their economic status would increase with carbon revenue and empower them to participate in the panchayat or other village / ward level institutions.

**G.1.2. Outside the project area**

**i) Supply of NTFPs and employment in processing industry**

- Supply of NTFPs from CDM plantations on a sustainable basis would create new processing industries and ensure raw-material supply to these industries. These could be located outside the project area and create new jobs.

**ii) Reduction in migration**

- Flow of carbon revenue in the long-term could have a negative impact on migration of rural population to the urban areas in search of employment. Carbon revenue, a new income source along with creation of large-scale reforestation and NTFP based industry may create new jobs and reduce migration.

**G.1.3 Potential socio-economic risks**

**i) Indigenous people**

- **Risks:** Himachal Pradesh has few migratory herders or trans-human community. They migrate along with their livestock in search of fodder during summer months. They travel regularly through different parts of the state with their livestock. The reduction in area of grazing land because of the A/R CM project could affect fodder resources for this community.
- **Mitigation:** Area proposed for the CDM project of about 4003.07 ha accounts for 0.14% of the total wasteland or degraded land and 0.2% of forest area of the districts. Thus the area dedicated for A/R activities is unlikely to have any significant adverse implications for the indigenous Gujjar community. Further, the State Forest Department has clear guidelines regarding the grazing rights of Gujjars and the project will adhere to these regulations. Care has been taken to



**PROJECT DESIGN DOCUMENT FORM  
FOR AFFORESTATION AND REFORESTATION PROJECT ACTIVITIES (CDM-AR-PDD) - Version 05**

select areas or land parcels where migratory rights do not exist. There is already a tribal action plan of the MHWDP.

*iv) Loss of cultural and religious sites*

No land with cultural and religious importance, for the local communities in the project area is proposed under the CDM project.

*viii) Access to grass, fuelwood and NTFP*

- **Risk:** Reforestation, fencing and regulations may lead to loss of access and supply to the local communities to the pre-existing grass, fuelwood and NTFPs.

**Mitigation:** Firstly, there will be no reduction in access to pre-existing grass, fuelwood and NTFPs, though regulated to ensure sustainable extraction. Secondly, reforestation and planting of multiple of tree species will ensure incremental grass, fuelwood and NTFP production and supply. Thirdly, there will be no restriction on harvesting and collection of enhanced grass production, NTFPs and fallen and dead dry woody litter and branches. Thus, there will be no reduction in access to fuelwood and NTFPs, indeed there will be increased supply with clearly defined access rules.

**G.2. If any negative impact is considered significant by the project participants or the host Party, a statement that project participants have undertaken a socio-economic impact assessment, in accordance with the procedures required by the host Party, including conclusions and all references to supporting documentation:**

>>

No significant negative socio-economic impacts are expected due to the implementation of A/R CDM project activities. As explained earlier there will be several positive socio-economic impacts due to the implementation of the project.

**G.3. Description of planned monitoring and remedial measures to address significant impacts referred to in section G.2 above:**

>>

Since, there is no significant negative impact because of the A/R CDM project, monitoring and remedial measures are not necessary.

**SECTION H. Stakeholders' comments**

**H.1. Brief description of how comments by local stakeholders have been invited and compiled:**

>>

The PDD was discussed in an all stakeholders meeting at the Project Headquarter (Solan) and in the two regional headquarters: Dharamshala and Bilaspur. The concerns raised in the meetings were incorporated and the PDD was revised accordingly. Subsequently it was presented to the cabinet of GoHP and approved. The project has now been revised with the PDD incorporating the comments of the validators and the document has been disclosed among all stakeholders. All these disclosures were undertaken in conformity with the World Bank disclosure policy.

The comments were collected from primary as well as secondary stakeholders

**Primary stakeholders:** The primary stakeholders are the village communities, represented by the GP, farmers and the State Forest Dept. The methods involved the following;



**PROJECT DESIGN DOCUMENT FORM  
FOR AFFORESTATION AND REFORESTATION PROJECT ACTIVITIES (CDM-AR-PDD) - Version 05**

- PRA for the GP members as well as with the whole village community of sample GPs representing all the watershed divisions
- Questionnaire survey with the individual sample households from all sample GPs

In fact, the consultation process was initiated between the village community and MHWDP authorities in the context of watershed development programme. This process was continued further during the design of the CDM project and the PDD.

#### **Details of consultation process with primary stakeholders**

Detailed discussion was held with the primary stakeholders in the selected sample GPs through PRA to inform and elucidate their interest for implementing A/R Project. In brief the project had 66 consultation meetings with all stakeholders inviting comments on the PDD and the operational approaches. During the discussion stakeholders were made aware of the issues such as the objectives of the project, implementation process, species choice, protection needs and arrangements, cost sharing mechanism, benefits from the flow of forest produce, biomass yield, CDM and carbon revenue. Their comments on these issues were recorded and compiled.

Primary stakeholders who participated in the discussion included the GP members, landless families, marginal farmers, small farmers, large farmers, other people residing in the village and local environmental officials.

<b>H.2. Summary of the comments received:</b>
---

>>

The key comments were related to the flow of CDM CER revenue and access to land, grass, fuelwood and NTFP from the plantations once the A/R CDM project was implemented. Following issues were raised during the PRA and discussion with communities.

#### **i) Selection of species for planting**

**Comment:**

As a part of the PRA exercise and consultations, stakeholders raised many questions about the species choice and they wanted fast growing species as well as tree species which provided multiple products.

#### **ii) Grazing**

**Comment:**

While stall feeding has been a major initiative by the GoHP and MHWSP, and large chunks of forestland are available for fodder collection, some villagers were curious to know if they could access surplus grass production likely to come due to CDM A/R activities.

#### **iii) Access to fuelwood and NTFPs**

**Comment:**

Similar concerns were also raised for accessing the deadwood/fuel and NTFPs likely to be accrued from tree plantations to be raised under the project.

#### **iv) Carbon revenue flow**



**PROJECT DESIGN DOCUMENT FORM  
FOR AFFORESTATION AND REFORESTATION PROJECT ACTIVITIES (CDM-AR-PDD) - Version 05**

**Comment:** The GP members as well as the farmers wanted to know how the income from the sale of CERs will be shared with them. What percent of the revenue will reach them? How it will be credited to them, as members of a GP or as individual farmers?

**Secondary stakeholders:**

Secondary stakeholders in the project include MHWDP, Forest Department, district level GP members and local level government officials. The views and comments of the secondary stakeholders were obtained through workshops, meetings and circulation of draft PDD.

**i) Flow of Carbon credits**

**Comment:** The State Forest Dept wanted to know how the CDM CER revenues will flow, and the share that would accrue to the Forest Department.

**H.3. Report on how due account was taken of any comments received:**

>>

**i) Selection of species for planting:** The CDM A/R project developers prepared a large basket of species for each model based on suitability to the location, flow of multiple products and rate of growth. The GPs and farmers will make the final choice from the basket of suitable list of species. Thus, the primary stakeholders will make the species choice; village GP members will make the final selection for the degraded forest and community land and individual farmer for the respective plot of land.

**ii) Grazing:** The GP members or the village community will have full access to grass produced. Evidence is available to show that the grass production will double with protection and management. Thus, the village community will obtain double the quantity of grass. The village community will be encouraged to shift to grass harvesting and stall feeding, which is already being practiced by many farmers. The watershed project authorities also have programmes to enable livestock owners to shift to high yielding cow breeds, which are normally stall-fed.

**iii) Access to NTFPs:** The community will have full access to all NTFPs produced from the tree reforestation models. Under the Participatory Forestry Programme guidelines, the communities will have full access to all the NTFPs, including grass, dead and fallen and dry wood and NTFPs.

**iv) Carbon revenue flow:** MoU or agreement is prepared according to which all the revenue from the degraded forest and community land will flow to the village GPs and revenue from private land will flow to the individual farmers. Only a small administrative cost will be deducted from the carbon revenue. The agreement is being signed between the MHWDP project authorities and the GPs and the individual farmers. The State government will endorse the agreement.

All the stakeholders appreciated the afforestation and reforestation project activities on the degraded forest, community and private lands. They welcomed the A/R activity in villages and panchayats. Primary stakeholders gave many positive comments, which would give a strong impetus for a successful implementation of the project. They appreciated the objectives of the project and showed interest in management of the plantations and are ready to share the responsibilities and enjoy the benefits including carbon revenue.



**PROJECT DESIGN DOCUMENT FORM  
FOR AFFORESTATION AND REFORESTATION PROJECT ACTIVITIES (CDM-AR-PDD) - Version 05**

**Annex 1**

**CONTACT INFORMATION ON PARTICIPANTS IN THE PROPOSED A/R CDM PROJECT  
ACTIVITY**

Organization:	H.P. Mid-Himalayan Watershed Development Project
Street/P.O.Box:	Forest Road
Building:	MHWDP, Hq
City:	SOLAN
State/Region:	Himachal Pradesh
Postfix/ZIP:	173212
Country:	INDIA
Telephone:	91-1792-223043
FAX:	91-1792-220064
E-Mail:	cpdmhwdp@yahoo.co.in
URL:	http://hpmidhimalayan.org
Represented by:	
Title:	Mr.
Salutation:	Chief Project Director
Last Name:	Kapoor
Middle Name:	Kumar
First Name:	Raj
Department:	
Mobile:	09418151154
Direct FAX:	
Direct tel:	
Personal E-Mail:	

Organization:	International Bank for Reconstruction and Development (IBRD) as Trustee of the BioCarbon Fund (BioCF)
Street/P.O.Box:	1818 H Street, NW
Building:	MC
City:	Washington
State/Region:	D.C.
Postfix/ZIP:	20433
Country:	United States of America
Telephone:	+1 202 473 1000
FAX:	+1 202 522 7432
E-Mail:	<a href="mailto:ibrd-carbonfinance@worldbank.org">ibrd-carbonfinance@worldbank.org</a>
URL:	<a href="http://www.carbonfinance.org">www.carbonfinance.org</a>
Represented by:	Joëlle Chassard
Title:	Manager, Carbon Finance Unit
Salutation:	Ms.
Last Name:	Chassard





## CDM – Executive Board

PROJECT DESIGN DOCUMENT FORM  
FOR AFFORESTATION AND REFORESTATION PROJECT ACTIVITIES (CDM-AR-PDD) - Version 05

Middle Name:	-
First Name:	Joëlle
Department:	ENVCF
Mobile:	-
Direct FAX:	+1 202 522 7432
Direct tel:	+1 202 458 1873
Personal E-Mail:	-

Organization:	Kingdom of Spain - Ministry of Environment and Rural and Marine Affairs
Street/P.O.Box:	C/Alcalá 92, 28009
Building:	
City:	Madrid
State/Region:	
Postfix/ZIP:	28009
Country:	Spain
Telephone:	+34 91-4361549
FAX:	+34 91-4361501
E-Mail:	and@mma.es
URL:	
Represented by:	Alicia MONTALVO
Title:	Director General
Salutation:	
Last Name:	MONTALVO
Middle Name:	
First Name:	Alicia
Department:	Spanish Office of Climate Change (OECC)
Mobile:	
Direct FAX:	
Direct tel:	
Personal E-Mail:	and@mma.es

Organization:	Kingdom of Spain - Ministry of Economy and Finance
Street/P.O.Box:	Po de La Castellana,
Building:	162
City:	Madrid
State/Region:	
Postcode/ZIP:	28046
Country:	Spain
Telephone:	+34 91 583 76 59
FAX:	
E-Mail:	
URL:	
Represented by:	Ms. Maria FERNANDEZ GARCIA
Title:	



CDM – Executive Board

**PROJECT DESIGN DOCUMENT FORM  
FOR AFFORESTATION AND REFORESTATION PROJECT ACTIVITIES (CDM-AR-PDD) - Version 05**

Salutation:	Ms.
Last name:	FERNANDEZ GARCIA
Middle name:	
First name:	Maria Jesus
Department:	International Finance Department
Mobile:	
Direct FAX:	+34 91 583 52 11
Direct tel:	
Personal e-mail:	<a href="mailto:dgfint@meh.es">dgfint@meh.es</a>

**Annex 2****INFORMATION REGARDING PUBLIC FUNDING**

There is no diversion of public funding in the project

**Annex 3****BASELINE INFORMATION**

Baseline vegetation and soil carbon as well as socio-economic data were collected using the following approach and methodology.

*Step 1: Selection of region*

The Mid Himalayan Watershed project consists of two broad regions namely Bilaspur and Dharamshala. These regions are characterized by sloping topography, degraded status of lands devoid of vegetation, and subjected to grazing. These factors influence the vegetation and soil carbon stocks and their rates of change. Thus, the project area is distributed in two broad administrative regions namely Bilaspur and Dharamshala.

*Step 2: Selection of watershed division*

Further these two regions are sub-divided into watershed divisions and all the divisions have been selected.

- *Bilaspur region:* Nahan, Swarghat, Namhol, Solan , Kullu, Rampur
- *Dharamshala region:* Dharamshala, Mandi, Chowari, Nurpur, Sujanpur

*Step 3: Selection of land categories*

Of the three land categories included in the project, namely degraded forestland, degraded community land and degraded and abandoned private land are identified as the baseline strata.

- *Degraded forestland:* These lands are located at a higher elevation and grazing pressure is relatively less as these land categories are farthest from the habitation.
- *Degraded community land:* These lands are under the control of the revenue department and communities have right of access to grazing and fuelwood collection. These are in the vicinity of village habitation.
- *Degraded and abandoned private land:* These lands categories are at lower elevation close to the valley and are closest to human habitation. They were cultivated under sloping or partially levelled and partially terraced condition. The lands included under the project have been abandoned for more than 10 years and are currently used for grass harvest and livestock grazing.

*Step 4: Selection of GPs*



**PROJECT DESIGN DOCUMENT FORM  
FOR AFFORESTATION AND REFORESTATION PROJECT ACTIVITIES (CDM-AR-PDD) - Version 05**

From the 10 watershed divisions, 64 land parcels spanning 42 sample GPs were selected for baseline survey of vegetation as well as soil sample collection, for PRA and household survey.

The rationale for sampling of 42 GPs is as follows:

- There are 177 project GPs
- ~25% of 177 GPs is 44
- This 42 GPs have been allocated across different baseline land categories of degraded forestland, degraded community land and degraded and abandoned private land and sub-strata of high, medium and low altitude in proportion to the area these sub-strata account for the total project area of 4003.07 ha.

*Step 5: Baseline vegetation survey*

Sample plots were laid randomly in each of the land categories present in a GP within a watershed division. Plots were laid for studying trees as well as non-trees. The dimensions of the tree and non-tree quadrats are as follows:

*Tree*

Dimension – 20 X 25 m

Number of plots - 5

*Non-tree*

Dimension – 5 X 5 m

Number of plots – 5

<b>Baseline stratum</b>	<b>Altitude</b>	<b>No. of GPs sampled</b>
Degraded forestland	High	9
	Medium	6
	Low	14
Degraded community land	High	5
	Medium	7
	Low	5
Degraded and abandoned private land	High	5
	Medium	5
	Low	8
<b>Total</b>		<b>64</b>

*Step 6 Tree measurements*

After laying a tree quadrat of above mentioned dimensions, all stems of height >1.5 m were identified and the girth or diameter (GBH/DBH) of the tree and height was measured and estimated, respectively. DBH is the most critical parameter required for estimating the aboveground biomass, as shown by the box in Step-7, where the majority of allometric equations require only DBH data.

*GBH/DBH* Measured using measuring tape for large trees and slide calipers for smaller trees



**PROJECT DESIGN DOCUMENT FORM  
FOR AFFORESTATION AND REFORESTATION PROJECT ACTIVITIES (CDM-AR-PDD) - Version 05**

*Height of the tree* Trees below 3 m height were measured and the height of the taller trees was visually estimated. The height data however is not used in calculations of aboveground biomass since all the allometric equations used require only diameter (DBH) data.

*Step 7a Estimation of biomass of non-trees-shrubs*

For estimating the biomass of shrubs or non-trees, the harvest method was adopted. All the grass and shrub biomass present within the non-tree quadrats was clipped and harvested. The fresh weight of the harvested biomass was taken. The weight of grass and shrubs within this quadrat was taken separately in order to estimate the grass and woody biomass separately.

*Step 1:* Species name and number in each shrub plot was recorded.

*Step 2:* The shrub biomass was harvested in each shrub plot.

*Step 3:* Fresh weight of the biomass was estimated.

*Step 4:* Dry weight of the biomass was estimated by taking a small quantity and drying it in an oven.

*Step 5:* The dry biomass expressed as dry tones is extrapolated to per ha from the sample area

*Step 7a Estimation of biomass of non-trees-grass*

The biomass of grass was also estimated by the harvest method. All the grass present within the non-tree quadrat was clipped, harvested and weighed to obtain the fresh weight. A known quantity of grass was weighed and dried in the oven to obtain the dry weight. Dry biomass of sample area extrapolated to per hectare.

*Step 8 Calculation of tree biomass*

There is very limited literature on the allometric equations for estimating the aboveground biomass stocks for tree species occurring in India (Murali et al, 2005). Volume of trees was estimated using DBH (D) and height (H) data and the same converted to biomass in tonnes using wood density value of 0.57 for tropical species (Brown, 1997). The stem biomass was then converted to whole tree biomass by multiplying with a BEF value of 1.2 – IPCC GPG default value for tropical broad leaved species.

The biomass of the sample area was then extrapolated to per ha and biomass expressed as dry tonnes per ha.

*Step 9 Estimation of total living biomass and total carbon*

In order to estimate the total biomass, the following steps were adopted.

- Aboveground biomass was estimated using the DBH (and in some cases height) values measured in sample plots for each species. The biomass of each tree was estimated and summed for the plots and extrapolated to per hectare value from sample plot area
- Using IPCC default BEF, total above ground biomass estimated from stem biomass
- Using IPCC default conversion factor, the belowground biomass was estimated as a fraction of aboveground biomass (0.24% of aboveground biomass)
- Total biomass is a sum of above and belowground biomass

$$\text{Total Biomass} = \sum (\text{Aboveground biomass} + \text{Belowground biomass})$$



**PROJECT DESIGN DOCUMENT FORM  
FOR AFFORESTATION AND REFORESTATION PROJECT ACTIVITIES (CDM-AR-PDD) - Version 05**

- According to IPCC, carbon fraction default value is 0.5 and therefore living biomass carbon is estimated by multiplying total living biomass with carbon fraction

$$\text{Total living biomass carbon} = \text{Total living biomass} \times \text{carbon fraction (0.5)}$$

*Step 10 Estimation of soil organic carbon*

Soil carbon density (tC/ha) was estimated based on stratified random sampling for the three broad land categories selected for A/R activities. Soil samples were collected at a depth of 30 cm from all land categories included in the A/R CDM project in a selected GP. Samples were collected in replicates and a composite sample prepared for analysis. Soil organic carbon was estimated in the laboratory using the Walkley Black method. The three broad land categories as well as the number of sample points selected for soil carbon estimation is given below.

<b>Land category</b>	<b>No. of sample points</b>
Degraded forestland	52
Degraded community land	8
Degraded and abandoned private land	38

*Selection of sample point:* The GPs and the land categories selected for vegetation sampling (for tree biomass estimation) were used for locating soil sampling points. The total number of sampling points selected for the three land categories are given above.

***Field sampling for soil carbon:***

The following procedure was adopted;

- The centre point of each of the baseline tree plots was marked
- The soil surface was scraped to remove the litter
- Soil was dug to a depth of 30 cm
- Thus, soil was collected from each of the 5 tree plots as replicates
- Soil from these five plots was mixed to obtain a composite sample
- The soil was collected in a polythene bag and transferred to laboratory for analysis

***Laboratory analysis:*** The Walkley-Black method was used for estimating soil organic carbon content.

***Bulk density estimation:*** Bulk density was estimated by collecting soil from 30 cm depth and filling it into a bottle and obtaining the weight and volume of the soil in the bottle.

$$\text{Bulk density (grams/cc)} = \text{Weight of the soil/volume of the soil}$$

***Calculation of soil carbon stocks:*** The content of organic carbon in soil estimated in percentage terms can be converted to tonnes per hectare using bulk density, depth of soil and area (10,000 m<sup>2</sup>).

$$\text{Soil organic carbon (t/ha)} = [\text{soil mass in 0-30 cm layer} \times \text{soil organic carbon concentration (\%)}] / 100$$

$$\text{Soil mass (t/ha)} = [\text{area (10,000 m}^2\text{/ha)} \times \text{depth (0.3 m)} \times \text{bulk density (t/m}^3\text{)}]$$



**PROJECT DESIGN DOCUMENT FORM  
FOR AFFORESTATION AND REFORESTATION PROJECT ACTIVITIES (CDM-AR-PDD) - Version 05**

*Step 11: Estimation of total carbon*

$$\text{Total Carbon} = [\text{Total Living Biomass Carbon} + \text{Total Soil Organic Carbon}]$$

*Step 12: Assessment of degraded state of baseline strata based on field studies*

Degraded lands were defined based on the tree crown and, biomass and soil carbon status of the land categories selected. The detailed approach for selecting land categories and parcels that are in a degraded state is given in Section A.7.

- Tree crown density obtained from remote sensing maps for the land parcels selected for the project, where only parcels with <10% tree crown were selected
- Soil organic carbon (tC/ha) estimated using the methods described above (Step 10) for the land categories and land parcels selected and compared with adjoining forests
- Vegetation status (tonnes of biomass/ha) determined using the methods described above (Steps 1-9)
- The soil carbon and vegetation biomass carbon is compared with that of values obtained for adjacent forests as well as the literature values for Himachal Pradesh.

Further, the topography of the land categories and parcels is characterized by a slope of about 15-20%, which enhances soil erosion.

**Annex 4****MONITORING PLAN**

Monitoring methods along with the indicators for estimating the GHG emissions and removals, according to the methodology AR-ACM0001, were described in Section E. The monitoring plan for the proposed A/R CDM project activity involves the following elements:

- Geographic position of the project boundary
- Monitoring of forest establishment and management
- Sampling design and stratification with sampling framework
- QA/QC plan

***1. Monitoring of forest establishment and management***

The details of methods and indicators to be monitored for assessing forest establishment and management practices are presented in this section. The monitoring methods also aim to ensure that the management practices are implemented in accordance with the PDD.

The activities to be monitored for monitoring of forest establishment were described in Section E.1.1. The parameters to be monitored are as follows:

**Table 4.1a:** Geographical location of plots

Parcel ID	Area (ha)	Sample Plot			
		Number	GPS location	Land Mark	Strata



**PROJECT DESIGN DOCUMENT FORM  
FOR AFFORESTATION AND REFORESTATION PROJECT ACTIVITIES (CDM-AR-PDD) - Version 05**

**Table 4.1b:** Species planted and survival in different stand models

Parcel ID:			Stand model:		Year of Monitoring:	
Area (ha)	Fast		Medium		Low	
	Species	Number	Species	Number	Species	Number

**Table 4.1c:** Species composition

Frequency: year 1 – 5- annual,

Species Composition					Stratum	Stand Model (No of Plants)		
Year	Parcel ID	Year of Planting	Area (ha)	Total number of plants		Fast	Medium	Low

**Table 4.1d:** Total area of all sample plots

Stand Model:			Stratum Code:			Parcel ID:			
Sample plot number	Total area (ha)			Total area (ha)			Total area (ha)		
	Reforestation			Community Forestry			Farm Forestry		
	High	Medium	Low	High	Medium	Low	High	Medium	Low





CDM – Executive Board

**PROJECT DESIGN DOCUMENT FORM  
FOR AFFORESTATION AND REFORESTATION PROJECT ACTIVITIES (CDM-AR-PDD) - Version 05**

**Table 4.1e:** DBH and height measurements

Parcel ID	Sample plot number	Strata	Species	DBH (cm)			Height (meters)
				DBH 1	DBH 2	DBH 3	

**Table 4.1f:** Status of contractual agreements

Parcel ID	Legal Status	Group Name	President's Name and Contact	Contract Signing Date

**2. Stratification and sampling for monitoring**

Preliminary stratification procedure is described in Section C. The final *ex ante* stratification of the project will be decided after implementation of project activities. The details of the methods for sampling and the sample size (number and size of plots) for monitoring are described in Section E.

**3. Sampling framework**

Measurement and calculation of carbon stock changes involves the following steps for estimation of aboveground biomass stocks as illustrated in Figure 4.1.

**PROJECT DESIGN DOCUMENT FORM  
FOR AFFORESTATION AND REFORESTATION PROJECT ACTIVITIES (CDM-AR-PDD) - Version 05**

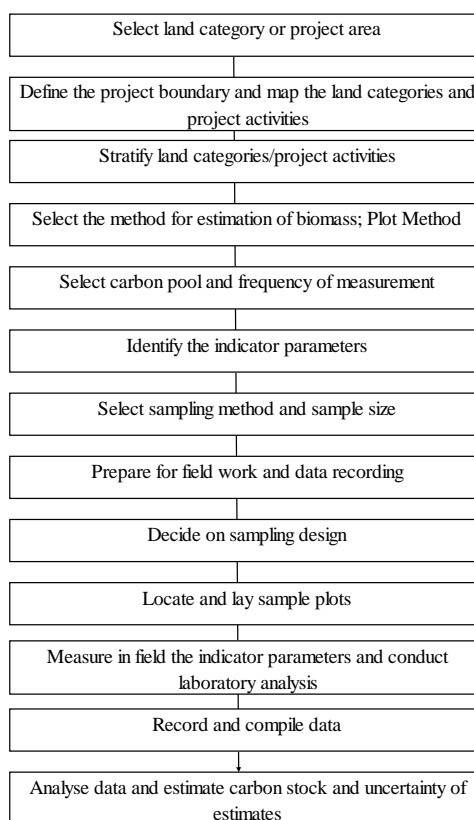

**Figure 4.1:** Steps in measurement and estimation of aboveground biomass stock

*Steps 1 to 3* are described in previous sections.

*Step 4: Selection of permanent plot method*

The permanent sample plots will be used for estimation of aboveground biomass of tree and non-tree vegetation. The plot method involves selection of an appropriate size and number of plots, laying them randomly in the strata selected and measuring the indicator parameters (e.g., tree DBH, height or grass production) and using different approaches such as allometric functions to calculate the biomass, and converting the sample plot estimate to per hectare and for the total project area. Permanent plot method enables monitoring of carbon stock changes or gains and losses on a periodic basis.

*Steps 5 & 6: Selection of carbon pool, frequency of measurement and identification of indicator parameters*

The selection of carbon pools and frequency of measurement of carbon pools was described earlier in this Section. The indicator parameters for measurement are also listed in Table 4.1. A description of the parameters to be monitored and measurement procedure is given below:

- i) *Name of the species* Vegetation type such as tree, shrub or herb will be recorded, followed by the species name. Among the trees, different species have different shape, size, rate of growth and wood density. Species name is important even for non-tree plant forms such as shrubs, herbs and



**PROJECT DESIGN DOCUMENT FORM  
FOR AFFORESTATION AND REFORESTATION PROJECT ACTIVITIES (CDM-AR-PDD) - Version 05**

grass. Biomass for tree species is estimated as volume or weight per tree, which can be extrapolated to per hectare based on the density and distribution of each species. While recording the species name and number, it is proposed to record other features such as

- *Status of tree crown* percent damaged or full crown
- *Dead or living tree* living, or dead and standing, or dead and fallen

*ii) DBH (Diameter at Breast Height) or GBH (Girth at Breast Height) for trees* This is one of the most important parameters, which represents the volume or weight of the trees, which can be converted to biomass estimates per unit area (tonnes/ha or tonnes/ha/year). DBH values along with the height parameters can be used for estimating the volume of the tree by simple equations. DBH values can also be used in allometric functions, where volume or biomass per tree or per hectare can be estimated. DBH is easy to measure in the field and also it facilitates repeated measurements, by marking the plot as well as the tree. DBH will be measured at a height of 137 cm above ground.

*iii) Height of trees* It is the most important indicator apart from DBH, used for measuring the volume or weight of the tree. Height parameter will be used in the allometric functions to estimate the volume or weight of the tree along with the DBH values.

*iv) Parameters for non-tree species* DBH and height parameters are not measured for non-tree species such as herbs and grasses. The biomass for non-tree species is estimated in terms of weight per unit area for each species, by actually harvesting and weighing all the herbs and grasses in the sample plots.

*Step 7: Selection of sampling method and sample size*

Sampling includes selection of the number of plots, size of the plots and shape of the plots. Carbon inventory will be estimated based by adopting a sampling design method. Stratified random sampling will be adopted for monitoring.

*Stratified random sampling:* The random sampling approach involves locating the plots in the field in an unbiased way. Stratified random sampling approach to be adopted involves the following steps and the stratification procedure adopted and sample size is described in Section E.

*Step 1:* Stratify the land categories and project activity area, namely high altitudinal strata of reforestation model

*Step 2:* A grid map of the project area, demarcating each land use category and reforestation model and parcels and a grid size of 25 m X 20 m will be adopted

*Step 3:* Each grid for the project reforestation models will be marked

*Step 4:* The sample grid numbers will be randomly picked, using random table or lottery system.

*Step 5:* Permanent tree plots will be located in the grids selected in the field with respect to some permanent visible land mark and the boundary of each tree plot will be marked using a GPS

*Step 7:* The map prepared with all the details, including the location of sample plots marked on it will be stored in a computer on a GIS platform.

Location of sample plots in the field will be achieved by overlaying the reforestation model map over the grid scale map, using GIS, and marking the plots in the selected grids. GPS measurements of the corner points of quadrats or plots will be recorded on the map for revisits and periodic measurements. For long-



**PROJECT DESIGN DOCUMENT FORM  
FOR AFFORESTATION AND REFORESTATION PROJECT ACTIVITIES (CDM-AR-PDD) - Version 05**

term monitoring the plots will be marked in the field as well as on the map using GPS readings and with reference to some permanent landmark, for easy identification on the ground.

*Statistical approach to sampling:* This approach involves selecting the size and number of plots based on the variability of vegetation and areas of the sampling strata. It involves conducting preliminary sample study to estimate the variance of the variable selected, which is the biomass stock in each land use system. The method also requires estimation of the cost of sampling. The sample size is estimated using a formula, which requires variance in each land use system, area, desired precision, and error estimate. The sampling procedure was presented in Section E.

**Trees:** Trees or stems above 5 cm DBH will be included in the tree plots. The dimension of plots is likely to be 25 X 20 m, finalize size will be determined after plantations are raised.

**Shrubs:** Shrub plots include trees below 5 cm DBH and perennial shrub species but with height above 1.5 m. For every tree plot two shrub plots will be selected. Shrub plots will be located inside the tree plots, at the rate of one per tree plot. Shrub plot size would be 5 m X 5 m.

**Herbs and grass:** The dimensions of the herb layer plots will be 1 m X 1 m and the number is double that of shrub plots.

*Step 8 Field measurements and data recording*

Estimation of biomass carbon stock or growth rate requires measurement of indicator parameters such as tree height and GBH. These parameters will be measured in the field through a sampling design. Above ground biomass is estimated for trees, shrubs and herbs/grasses. The biomass of trees, shrubs and herbs will be measured using the following steps:

*Step 1:* Select the sample size, locate, and mark the sample plots for trees, shrubs and herbs on the ground

*Step 2:* Select the parameters for tree, shrub and herb biomass and procure all the materials required for field studies

*Step 3:* Measure the parameters for trees; species, height, DBH and status or features of tree

*Step 4:* Measure the parameters for shrubs; height, DBH and weight of the woody and non-woody biomass

*Step 5:* Measure parameters for herbs/grass; species, number of plants, weight of the plants in the sample plots

*Step 6:* Record all the parameters in the standard formats for trees, shrubs and herbs/grass

Steps 1 and 2 have already been described in earlier sections. Steps 3 to 6 are described in the following section. These largely focus on measurement of different parameters as indicators for estimating the plant biomass stock.

*Aboveground biomass of trees*

Trees are woody perennial plants having a single, usually elongated main stem with few or no branches on its lower part. Trees could be large or mature (>30 cm DBH) medium sized or growing (10–30 cm DBH) or regenerating seedlings (<10 cm DBH). Plants belonging to a tree species will be considered for measurement in tree quadrats, if the height of the plant is over 1.5 m and with a DBH of >5cm (a girth of about 15cm).

**PROJECT DESIGN DOCUMENT FORM  
FOR AFFORESTATION AND REFORESTATION PROJECT ACTIVITIES (CDM-AR-PDD) - Version 05**

*Parameters to be measured include species, number of stems, DBH, height, status of regeneration, dead and standing tree and extent of damage to the tree.*

**DBH** DBH is easy to measure and verify. It requires only a measuring tape or a caliper and a marker. DBH is measured using the following procedure:

- Mark 137 cm above ground on tree trunk
- Place the calipers/tape at 137 cm
- Measure and record the DBH or GBH in cm
  - If a tree has multiple shoots count and measure GBH/DBH for all shoots
  - If the tree is large normally girth is measured using a measuring tape
  - If the tree is young and has girth lesser than the prescribed, measure DBH using a slide caliper
  - If the tree is on the border line, and if >50% of the girth is inside the plot include it for the measurement in the sample plot

A tree could have multiple and/or crooked shapes, could be slanting, and could be on a sloping hill. Measurement technique for irregularly shaped trees and under different land conditions is illustrated in the following figure.

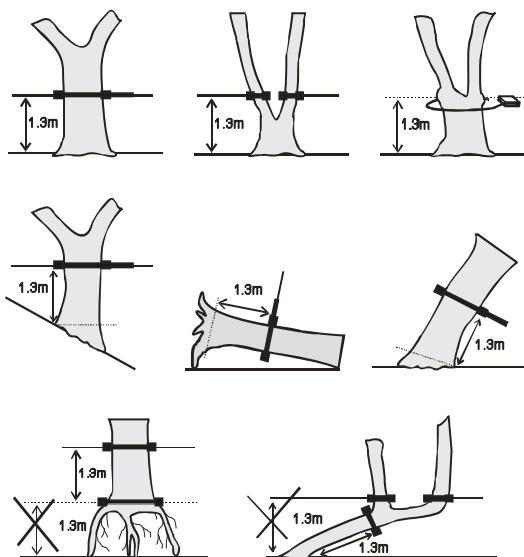

Measuring DBH or GBH for trees of different shapes and forms

**Height** Tree height normally refers to total tree height defined as the vertical distance from the ground level to the upper most point. Tree height is also often referred to as the merchantable height, since many allometric equations are derived for this height. Height is measured for all the tree stems for which DBH is measured. Measurement of tree height is difficult for tall trees, unlike DBH, especially, in a dense forest or plantation, with dense tree stems and overlapping tree crowns.

Tree height can be measured using various instruments or even a simple tape. However, measuring the height of individual trees with overlapping tree crowns and trees in a dense forest or plantation, poses a challenge for measurement even using instruments. Trees <3 meters will be measured using a graduated height stick, by holding a stick against the side of the tree. Clinometer is one of the instruments used for



**PROJECT DESIGN DOCUMENT FORM  
FOR AFFORESTATION AND REFORESTATION PROJECT ACTIVITIES (CDM-AR-PDD) - Version 05**

measuring the height of the trees. Mark out a horizontal distance of 10 meters from the tree from where the tree can be viewed using a clinometer, if necessary increase the horizontal distance by moving away from the tree beyond 10 meters. If the tree plot is located on a steep slope, view the tree from across the slope to obtain the horizontal distance. Sighting the tree through the clinometer, align the centre line with the base of the tree (ground level on the upside slope) and record the reading on the percent scale (base angle %). Next aim the clinometer to the top of the tree and record the reading on a percentage scale. Calculate the height using the following equation

$$\text{Height (m)} = \frac{\text{Top angle (\%)} - \text{Base angle (\%)} \times \text{Horizontal distance}}{100}$$

**Tagging of trees** The trees, which are perennial, will have to be measured periodically over a number years. Thus, to enable location of tree species and number, it is desirable to mark or tag the trees. This is achieved by fixing aluminium or other metallic tags to the tree.

Location: GPS reading: Parcel ID:		Land use system: Stratum:			Plot no: Size of the plot			Investigators: Date:		
S. No	Species name	Tree number	GBH (cm)					Planted or regenerated	Height (m)	Status of crown <sup>1</sup>
			Stem1	Stem2	Stem3	Stem4	Stem5			
1										

<sup>1</sup> indicate the percentage crown cover present or damaged

**Shrubs** Shrubs are woody plants of relatively low height often less than five meters, having several stems arising from the base and lacking a single trunk. Shrub plots include shrub species as well as younger trees with DBH lower than what is defined for the trees in the tree plots. Shrub plots are located inside the tree plots.

*Parameters to be measured include* species, number of stems, DBH, height and weight of the shrub biomass from the sample plot.

*Demarcation of the shrub plots and the boundary* The method of laying the shrub plots was described in the earlier section. The shrub plots will be located at one of the randomly selected corners of the tree plot. If a shrub is on the boundary line of the plot, it will be included into the plot if >50% of the shrub crown is within the plot.

*Procedure for measuring trees in shrub plots* The following steps will be adopted to measure the parameters in the shrub plots:

- Step 1: The shrub plots will be located in the tree plots
- Step 2: Start from one corner of the shrub plot and record indicator parameters and mark the plants after measurement, with a chalk or paint
- Step 3: Record the species and the number of shrub plants under each species
- Step 4: Measure the height of the tree using methods described for trees
- Step 5: Measure DBH of all tree plants of >1.5 m in height in the shrub plot and if multiple shoots are present, record DBH for all
- Step 6: Record the name, height, DBH and other features for each shrub plant in the formats.



**PROJECT DESIGN DOCUMENT FORM  
FOR AFFORESTATION AND REFORESTATION PROJECT ACTIVITIES (CDM-AR-PDD) - Version 05**

*Procedure for measuring non-tree vegetation* This could include annual or perennial shrubs as well as very young tree seedlings (of height <1.5m). Estimation of non-tree biomass in shrub plots will be based on harvest method for annual as well as perennial shrubs. Tree seedling could be excluded from harvest procedure.

*Biomass of annual shrubs* will be estimated by clipping the shrubs according to each species in the shrub plot and taking fresh weight of the plants. Dry weight of the biomass can be estimated by taking a known quantity (of 0.5 to 1.0 kg) of sample and drying it in the oven.

*Biomass of perennial shrubs* is estimated by harvesting the perennial shrubs and estimating the fresh and dry weight of the shrubs. However, if a shrub species is yielding an economically valuable product, such species need not be harvested or a few representative shrub plants could be harvested to get a mean weight of a shrub plant. The mean weight of sample shrubs harvested can be extrapolated to the whole plot.

Location: GPS reading: Parcel ID:		Land use system: Stratum:			Tree plot no: Shrub plot no: Size of the plot:		Investigators: Date:	
S. No.	Species	Diameter (cm)			Height (m)	Biomass – Fresh weight (kg)		
		DBH1	DBH2	DBH3				
1								

**Herbs** Herbs are non-woody plants that usually die at the end of the season. Herb layer biomass includes all annual plants, regenerated saplings and grass biomass. Herb layer plots of size (1x1m) will be selected. Herb layer biomass is part of the annual carbon cycle and estimated through harvest method during the peak growth period.

*Parameters* Species name, number of plants and fresh weight of standing herb biomass are the parameters to be recorded.

*Demarcation of the herb plots and the boundary* The herb plots are usually 1x1 m in size and are marked at the two opposing corners of each shrub plot.

*Measurement of the herb vegetation* This includes recording of the species name and harvesting the herb biomass to determine the weight. The following steps could be adopted.

*Step 1:* Recording of the species name and number in each herb plot. The percent ground cover of the herb in the plot would also be recorded according to species based on visual observation.

*Step 2:* The herb plants will be harvested according to species in each herb plot.

*Step 3:* Next the fresh weight of the herb biomass according to species would be estimated

*Step 4:* Dry weight of the fresh herb biomass would be estimated by taking a small quantity and drying it in an oven.

*Step 9 Data recording and compilation*



**PROJECT DESIGN DOCUMENT FORM  
FOR AFFORESTATION AND REFORESTATION PROJECT ACTIVITIES (CDM-AR-PDD) - Version 05**

Data recording formats have been developed for tree, shrub and herb species in sample plots. These formats are largely for use in the field. The data entered in these formats in the field would be verified and entered into a database for analysis. Some of the following precautions and steps would be followed to ensure correct recording in the field and its compilation in a computer for obtaining accurate estimates of the biomass are as follows:

- Use of the appropriate data entry format for trees, shrubs and herbs
- Ensure to enter the location name, date, plot number, vegetation type and name of the field investigator
- Enter and verify the GPS readings of the plots
- Enter and verify the units of height, DBH and weight
- Ensure all the relevant data recording cells in the formats are entered, before departing from the field location
- Verify the data recording formats as quickly as possible, after returning from the field, for any corrections or conversion of traditional units of measurement to the standard units such as metric system
- Codify if any entry requires the use of codes, by converting the qualitative information using the codes
- Develop a user friendly data entry system for computer analysis and for archiving of data
- Verify all the data entered and store in the database

*Step 10 Calculation of aboveground biomass*

Aboveground biomass would be estimated using biomass estimation equations for the dominant species raised in the reforestation models. These equations are available. The following steps would be adopted for estimating above ground biomass:

- i) Select the biomass equation relevant to the region, plantation species and age of the stand
- ii) Tabulate and enter the tree number, DBH and height (H) data into a computer data analysis package such as Excel or SPSS for each sample plot
- iii) Enter the biomass equation in the data file or worksheet for estimating the weight of the individual tree (kg/tree) for a given DBH
- iv) Estimate and add the weight of each tree derived using the DBH values from the sample plot selected
- v) Add up the values of total weight of the trees in each of the sample plot to obtain the total weight of all the trees in the sample plots selected for the land category, reforestation model and stratum
- vi) Extrapolate the biomass of trees from the sampled area to per hectare (tonnes/ha)
- vii) If the biomass equations provide volume (in m<sup>3</sup>) estimates. These will be converted to biomass by multiplying the volume by the wood density of the tree species in the reforestation model. Wood density would be assessed from the sample plots of reforestation model for different species or collected from the research studies.

*Step 11* The above ground stem biomass estimated will be converted to whole tree biomass using the BEF factor of 1.2 based on the IPCC default value, since no local BEF factors are available.

*Step 12 Calculation of belowground biomass*

Belowground biomass will be estimated using the IPCC default value of 0.24 of aboveground biomass. The aboveground biomass values obtained in Step-10, will be multiplied by the default value of 0.24, to





**PROJECT DESIGN DOCUMENT FORM  
FOR AFFORESTATION AND REFORESTATION PROJECT ACTIVITIES (CDM-AR-PDD) - Version 05**

obtain the belowground biomass value. Efforts will be made to obtain local aboveground and belowground biomass ratios, for the dominant species of the reforestation models raised in the project.

*Step 13 Calculation of total biomass stock for species in a reforestation model*

Total biomass carbon stock per hectare will be estimated by adding the aboveground and belowground biomass values calculated for each species belonging to the reforestation model.

*Step 14 Calculation of biomass carbon stock values*

The biomass values estimated per hectare for each reforestation model will be converted to tonnes of carbon per hectare using the IPCC default value of 0.5. Efforts would be made to obtain local conversion values for the dominant tree species.

#### 4. QA/QC plan

Quality control (QC), quality assurance (QA) and verification procedures are very important components of carbon inventory process, particularly to reduce the uncertainty involved in the estimation of carbon stock and changes. IPCC (2003 and 2006) provide the definitions and procedures for QA, QC and verification to enhance transparency and accuracy of the estimates of carbon inventory.

- *Quality Control* is a system of routine technical activities to measure and control the quality of the inventory as it is being developed, and is designed to:
  - o Provide routine and consistent checks to ensure data integrity, correctness and completeness
  - o Identify and address errors and omissions
  - o Document and archive inventory material and record all QC activities.
- *Quality Assurance* is a planned system of review procedures conducted by personnel not directly involved in the inventory compilation/development process.

QA/QC procedures will be developed and adopted particularly for the following activities;

- Field measurements
- Sample preparation and laboratory measurements
- Data entry and analysis
- Data storage and management

*Quality control procedures:* General QC procedures include quality checks related to calculations, data processing, completeness, documenting, and archiving procedures. Examples of QC activities and procedures involve the following:

- Check the assumptions used in the models
- Check the sampling procedure
- Check for transcription errors in data inputs
- Check the calculation procedures of carbon stocks and changes and units and conversions
- Check the time trends in long-term monitoring for any outliers
- Review internal documentation and archiving
- Check the suitability of use of any default data or coefficients
- Check the integrity of database files



**PROJECT DESIGN DOCUMENT FORM  
FOR AFFORESTATION AND REFORESTATION PROJECT ACTIVITIES (CDM-AR-PDD) - Version 05**

- Confirm the appropriate data processing steps are correctly represented in the database
- Confirm the data relationships are correctly represented in the database
- Ensure that data fields are properly labeled and have the correct design specifications
- Ensure adequate documentation of database and model structure

*Quality assurance review procedures:* QA comprises activities outside the actual carbon inventory processes. The estimates of carbon stocks and changes may be reviewed by external agencies in an unbiased way. It is important to involve experts or reviewers who were not involved in the carbon inventory estimations. This requires an expert review to assess the quality of the carbon inventory and to identify areas where improvements are necessary. QA procedure involves expert peer review, involving:

- Review of calculations and assumptions
- Review, if the major models used have undergone peer review

Assessment of documentation of models, input data and other assumptions.

- - - -

**History of the document**

<b>Version</b>	<b>Date</b>	<b>Nature of revision</b>
05	EB 55, Annex 22 30 July 2010	Restructuring to reflect changes applied in the design of approved A/R CDM baseline and monitoring methodologies. Due to the overall modification of the document, no highlights of the changes are provided.
04	EB 35, Annex 20 19 October 2007	<ul style="list-style-type: none"> <li>• Restructuring of section A;</li> <li>• Section “Monitoring of forest establishment and management” replaces sections: “Monitoring of the project boundary”, and “Monitoring of forest management”;</li> <li>• Introduced a new section allowing for explicit description of SOPs and quality control/quality assurance (QA/QC) procedures if required by the selected approved methodology;</li> <li>• Change in design of the section “Monitoring of the baseline net GHG removals by sinks” allowing for more efficient presentation of data.</li> </ul>
03	EB 26, Annex 19 29 September 2006	Revisions in different sections to reflect equivalent forms used by the Meth Panel and facilitating the transparent selection of an approved methodology for the proposed A/R CDM project activity.
02	EB 23, Annex 15a 24 February 2006	Inclusion of a section on the assessment of the eligibility of land and the Sampling design and stratification during monitoring.
01	EB15, Annex 6 03 September 2004	Initial adoption.
<b>Decision Class:</b> Regulatory <b>Document Type:</b> Form <b>Business Function:</b> Methodology		